

Nistune Z32 ECU Modifications for R33 RB25DET Skyline Installation

Revision 10 – 26 May 2013

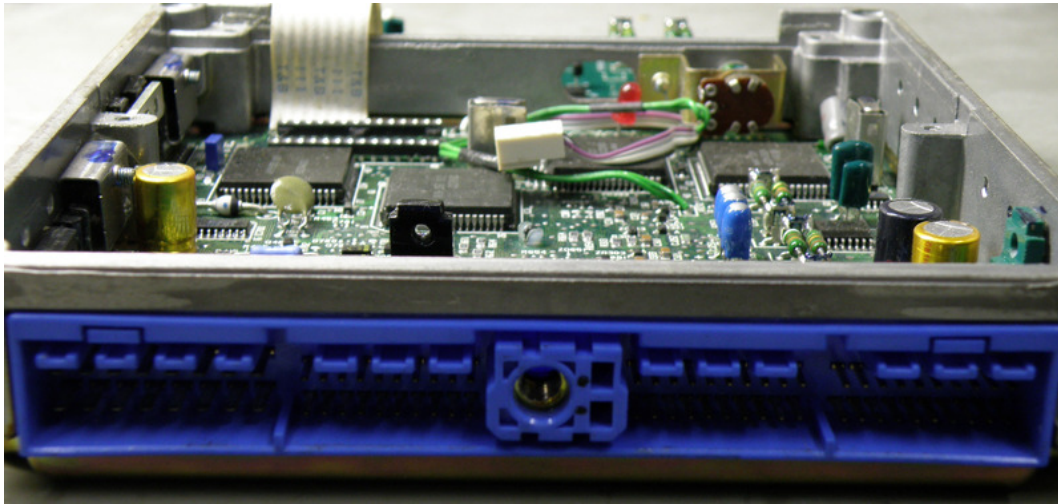

Thanks to Eric at DTA Motorsports and Andrew H for their help with previous versions. Many thanks and credits to Skyline Stu for the Rev 10 version of this document.

Overview

Fitting of the Z32 ECU is a functional and cost effective way to tune the R33 RB25DET Skyline when fitted with a NISTune board. The main ECU pin-outs are the same, so the Z32 ECU will actually plug into the R33 without modification.

There are some secondary signals which differ between the two ECU's. So for best integration into a standard R33 Skyline we've provided some basic instructions detailing the changes.

As a minimum it's recommended to do the resistor modification to correct the Fuel Temperature input – this will avoid incorrect fuel temperature measurements affecting the tune (see Section 5).

Instructions are for modifying the Z32 ECU for a direct R33 plug-in. This saves re-wiring the R33 harness - which means the standard ECU can easily be re-fitted if required. The same outcome may be realised by modifying the wiring harness if you'd rather not modify the ECU.

NISTune has provided a base image which consists of the Z32 base with R33 maps/tables merged. Files can be found in the NISTune ROM pack (from V3 onwards) under the Type 2/ECR33_RB25 folder (refer downloads section at www.nistune.com).

These files should provide a good starting point for tuning. Experience has shown that an RB25DET running the standard 370cc injectors and standard AFM will run quite well before any tuning even takes place.

Base images are configured for Series 1 R33 engines. Series 2 use a different airflow meter, so be sure to change the airflow meter in NISTune (Operations, Change Mass Airflow Meter) when you first connect to your ECU. Response curves for both airflow meters are very similar, so this should have minimal affect on the rest of the tune (K constant, load scales etc.).

Notes

1) The Z32 uses a switch on the TPS (Throttle Position Sensor) to sense closed throttle. R33 RB25 S1 does not. The Z32 ECU will use default "limp" values to determine TPS closed for idle calculations. This works quite effectively provided TPS is adjusted correctly.

2) We recommend Z32 (8 bit) ECU's for this modification. These can be any JDM , EDM or 1990-1992 USDM model ECU. It does not matter if the ECU is naturally aspirated or turbo, manual or auto. (Nissan part numbers 23710-30Pxx, 31Pxx, 37Pxx, 40Pxx, 41Pxx, 46Pxx, 47Pxx and 48Pxx).

Avoid later model USDM (1993-1996) 16 bit Z32 ECU's (Nissan part numbers 23710-45Pxx, 53Pxx, 51Pxx).

3) Note that most USDM Z32 ECU's are not stamped with a Nissan part number. However there is a manufacturer (JECS) part number which begins with A18. We can work out the Nissan part number if you contact us with the JECS part number, or you can connect to the ECU using any consult tool to retrieve the Nissan part number.

Instructions provided involve modifications to the ECU circuit board. Do not attempt this unless you are proficient in this type of work. No responsibility taken for information provided. Double check your work and continuity check all modifications on the ECU connector before using in the vehicle!

Important Soldering Notes

If you already have the equipment, you should know how to use it confidently.

Tools Required

Temperature Controlled Soldering Station with FINE (0.8mm or 1.0mm Tip)
SMD Electrical Soldering flux - liquid or paste (DO NOT USE PLUMBING FLUX)
Solder, 0.5-1.0mm
Desoldering braid, 1.5mm
Acetone or paint thinner
Small Paintbrush with Natural Bristle. Please, NO Plastic or Nylon parts!!
PCB Lacquer
Small Tweezers

This modification to the ECU requires you to remove several surface mount components and add in new interconnections.

The easiest way to do this is first clean the board around the area with a good solvent. Acetone is easy to get and works fine. A small natural bristle detail paintbrush works fantastic for cleaning away the conformal coating. Don't be afraid to give the area a real good wash down. Don't contaminate your large container by dipping the brush into the fluid, instead use a small glass jar or metal tin.

On the bottom side when desoldering, 365°C is needed to soften the SMD adhesive. On the top side desolder at a cooler 345-355°C. For soldering use 335°C. Clean the tip and now add some fresh solder to each of the SMD pads.

In this case, a good dollop of solder is OK. With your soldering iron, alternately heat the pins up for a second or so. Don't push downwards very hard, as you could strip a track off. The solder/component should retain enough heat after several swaps and will come off with a slight push. A pair of very fine tweezers makes this much easier.

Now clean the pads with a bit of solder wick and SMD flux. SMD Flux is absolutely necessary for a good job. If you find it won't melt off, add a little solder to the end of your wick (plus a little fresh flux). Add some fresh solder to the pads where the wires are to go, it makes your job much easier.

Clean the circuit board again with the acetone. Be generous. Finally, get some PCB lacquer and cover the reworked area. (in Australia get the Jaycar NA-1002 spray. It's probably the same stuff that JECS use)

1) Knock Sensor inputs – pin 23/24

The R33 RB25 engine uses twin knock sensors with Nissan part number 22060-56S10 (shared with R32 RB20DET). Z32 VG30 only uses a single knock sensor but with different Nissan part number 22060-30P00 (shared with various SR20 engines).

RB25 knock sensor wires 23 (cylinder 1-3) and 24 (cylinder 4-6) go into the Z32 ECU however the Z32 ECU only uses a single knock sensor input, on pin 23.

After customer feedback we recommend only leaving a single knock sensor connected which will cover knock for part of the engine block.

Otherwise we recommend stubbing out the knock sensor input by using a resistor to remove knock sensing input completely if during tuning the ECU appears to be oversensitive and pulling additional timing.

Stubbing out involves cutting the pin 23 knock sensor wire at the loom and soldering to a 470Kohm resistor between this wire and sensor ground (pin 30) on the ECCS harness.

Note: Internal modification alternative:

- (a) Bottom side of ECU. Solder 470K ohm resistor between C860 ground pin and pictured knock sensor through hole which comes from Pin 23

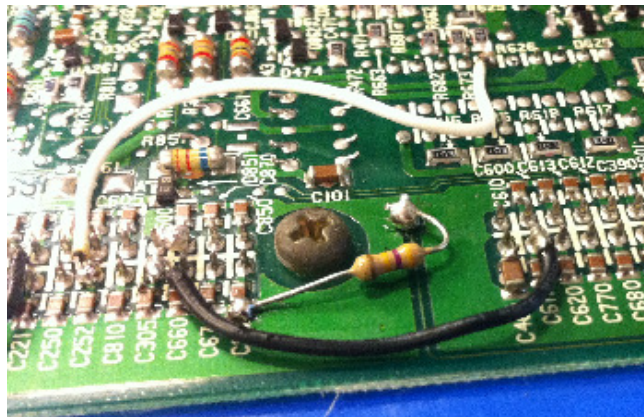

- (b) Cut the track from Pin 23 to the knock sensor track through hole on the top side of the ECU

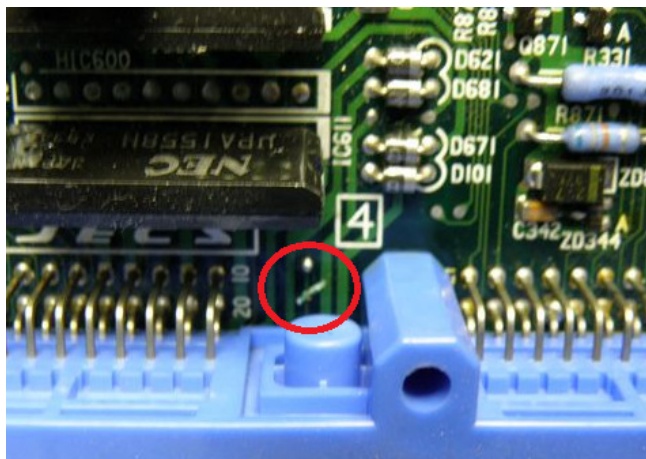

2) O2 Sensor inputs – pin 29/55

RB25 uses a single O2 sensor. Z32 uses twin. Link the O2 sensor input for RB25 (pin 29) to pin 55 so both O2 sensor inputs (LHS and RHS) receive a signal. This avoids the potential condition of RHS bank being open circuit (and assigned a default value of 0.3 volts by the ECU) meaning a potentially lean condition.

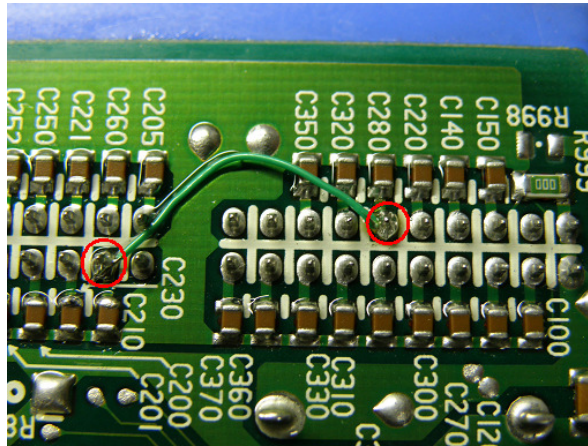

Link pins 29 - 55

3) Power Steer switch input – pin 19/34

RB25 power steering input goes to pin 19. This pin is used to drive the rad fan relay on Z32, so this signal must be moved to the Z32 power steer input pin (pin 34). This is achieved by linking across two pins and then isolating the original drive signal by removing a resistor on the top side of the board.

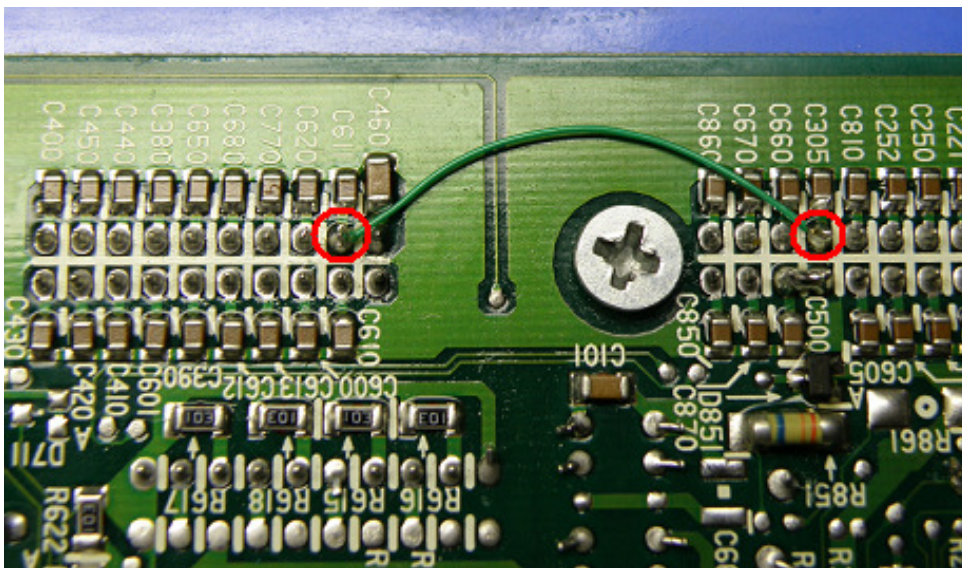

Link pins 19 – 34

The resistor is R613. To find it, check that the blue harness connector is facing you. Then identify where the plastic spacer comes through the circuit board. R613 is located 1.5cm to the left and slightly down. This isolates the output driver for the rad fan relay.

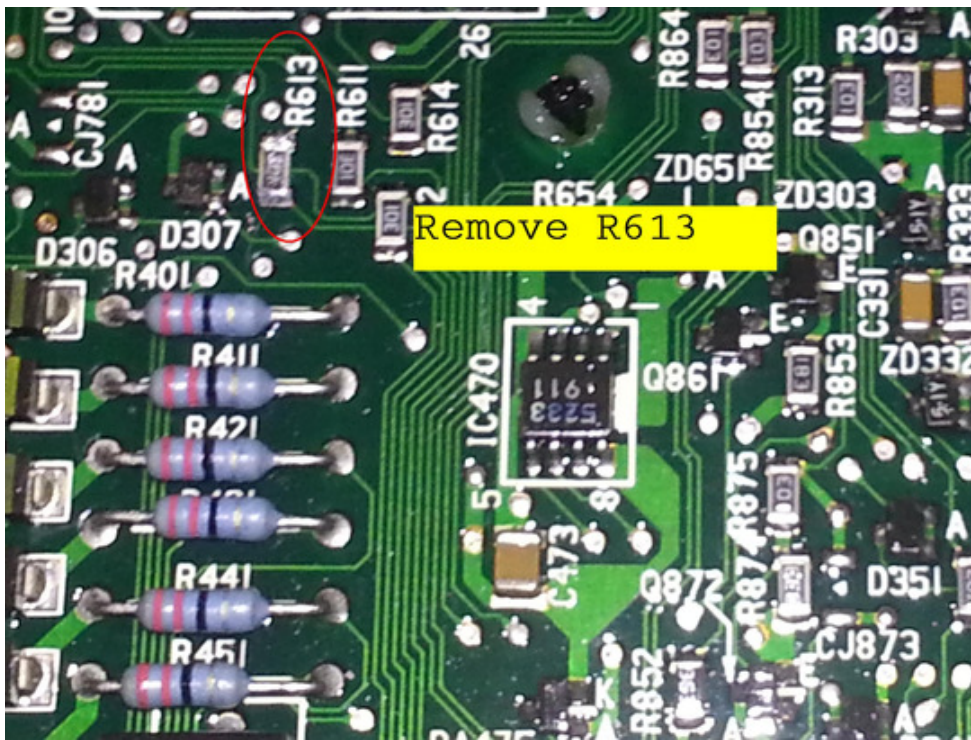

Remove R613 Surface mount component resistor

4) Fuel Temperature input – pin 36 * *Series 1 and Series 2*

Z32 ECU uses a fuel temperature sensor and R33 RB25 does not. A Diagnostic Trouble Code (DTC) will be raised by the Z32 ECU if it senses that the Fuel Temperature voltage is out of range

Series 1 does not have a wire connected to this pin. Series 2 ECU has the FICD wiring on this pin. We can disable this pin on both ECU styles by removing factory configuration jumper CJ252 (Marked 000). This is located on the top side of the circuit board 1.5cm to the right of the plastic plug.

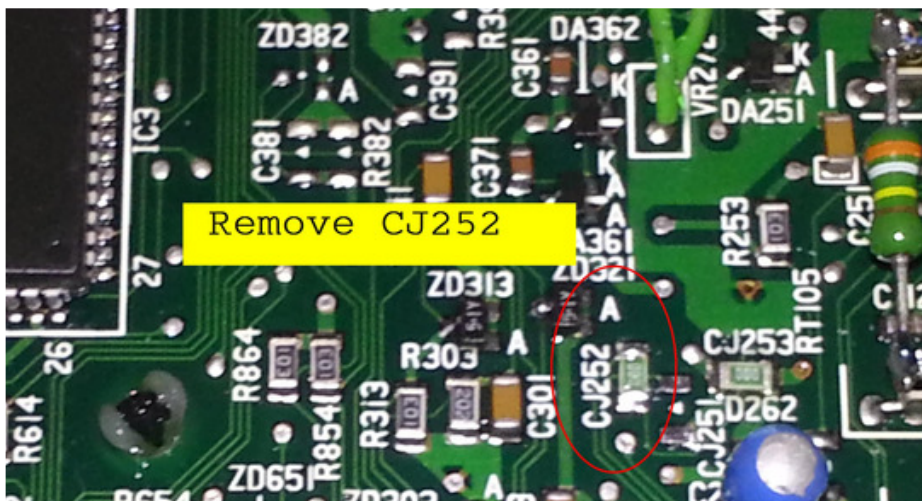

Remove CJ252 surface mount resistor

Bottom side of ECU put 2.2K ohm resistor in parallel to R252 to put Z32 ECU Fuel Temp input to a valid reading.

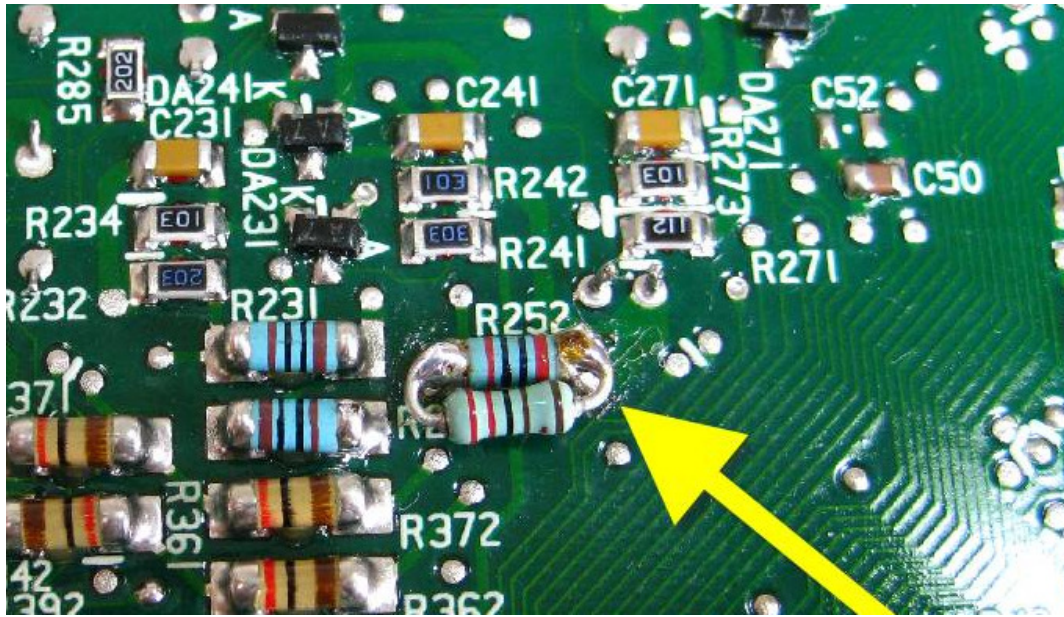

Add 2.2K resistor inline with ECU R252 resistor

Hint: To find the resistor have the bottom side of the ECU with the blue plug facing your left. In the middle of the ECU is a black insulator. The resistor is 2cm up and 1cm right from this insulator

5) Exhaust Over Temp Output – pin 33 * *Series 1 and Series 2*

Z32 ECU uses this line to drive the FICD (Fast Idle Control Device) – for idle up when the air conditioner is on.

FICD is driven separately on the R33 Series 1 RB25 via the air conditioner system (not via ECU) and driven from pin 36 on the R33 Series 2 RB25.

On the Series 2 FICD functionality requires routing a wire from the Z32 FICD output driver (pin 5 of IC621) directly to pin 36 (RB25 FICD output pin) and a track being cut.

Series 1

The R33 RB25 engine uses pin 33 for the Exhaust Overtemp Lamp on the dash. This line should be disconnected to avoid the lamp being illuminated in the vehicle. This is accomplished by removing Resistor R651. It is located on the bottom side, 3cm down from the centre support and slightly to the right.

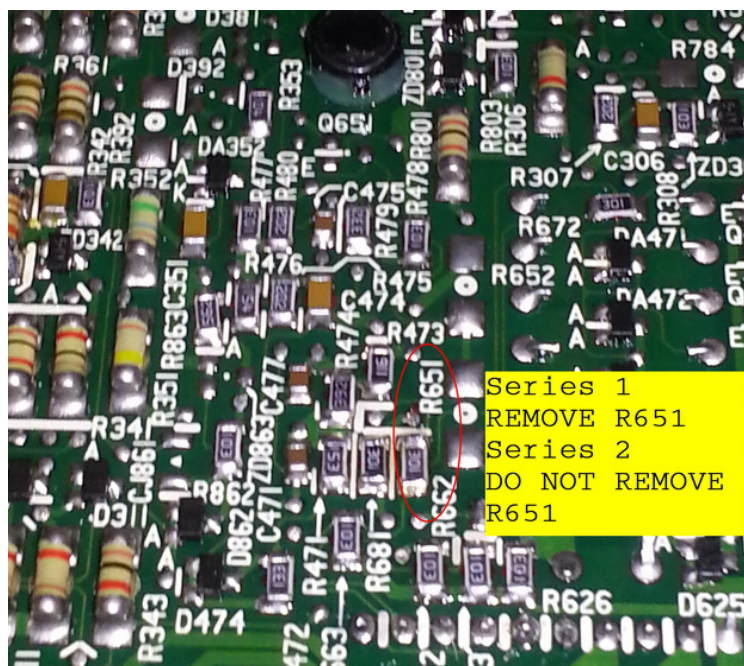

Note: It is next to another 2 resistors. R651 is the right most resistor. Remember this one need more heat so be patient.

Series 2

Series 2 has the FICD wire connected to pin 36.

Cut the track to isolate pin 33 so the EGT lamp does come on when the FICD activated. Do this by cutting a track near D621 and C671. Cut it with a sharp blade several times, being careful not to cut any other tracks in the area or yourself. Inspect the cut closely using a magnifying glass to make sure there is no conduction in the track.



Cut Exhaust Temp Lamp

Note: This is located about 1.5cm up from the central 'hump' in the harness connector and is near the large black driver IC's. IC611 and IC621.

6) Air Conditioner FICD – pin 36 * *Series 2 only*

Series 2 FICD functionality requires routing a wire from the Z32 FICD output driver (pin 5 of IC621) directly to pin 36 (RB25 FICD output pin) as pictured below.

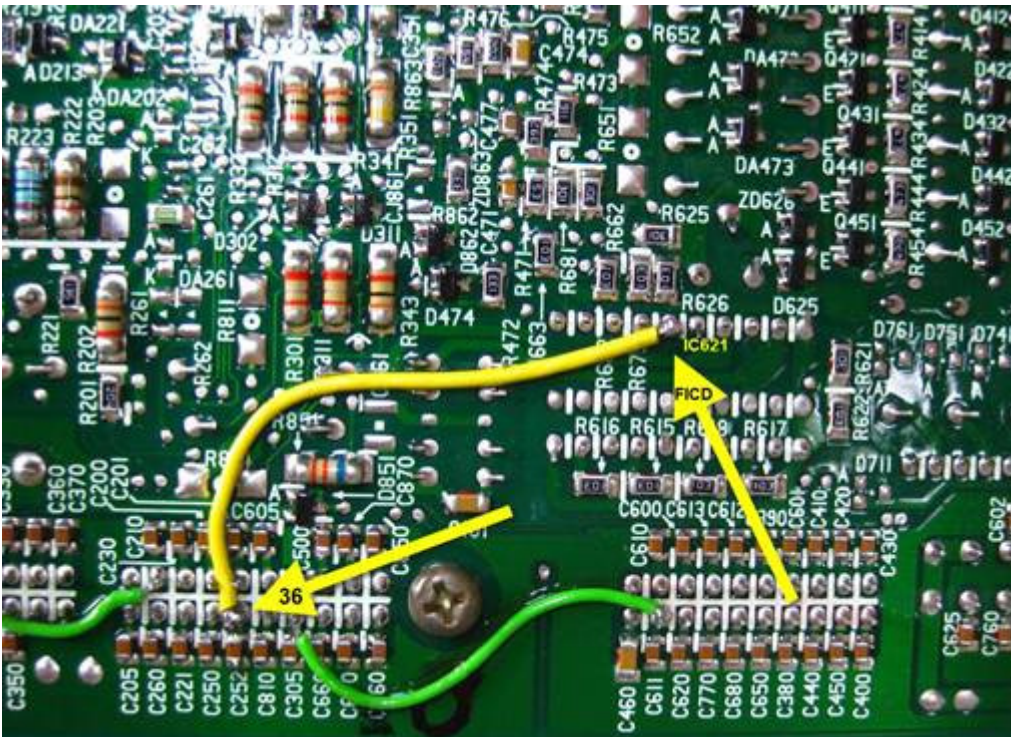

7) Injectors/IGN signals

Swapping of injector/IGN signals is not required. Although the pin assignments on the ECU's are different, when the Z32 ECU is used with R33 RB25DET wiring loom, the injector banks correspond with the intended injection order. So no modification is required.

RB25DE / RB25DET ENGINE

2. ECCS CONTROL UNIT PIN LAYOUT (RB25DE / RB25DET)

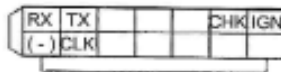

Terminal No.	Description	Terminal No.	Description
1	IGN SIG (pwr transistor ctrl sig) Cyl. No. 1	11	IGN SIG (pwr transistor ctrl sig) Cyl. No. 6
2	IGN SIG (pwr transistor ctrl sig) Cyl. No. 5	12	IGN SIG (pwr transistor ctrl sig) Cyl. No. 2
3	IGN SIG (pwr transistor ctrl sig) Cyl. No. 3	13	IGN SIG (pwr transistor ctrl sig) Cyl. No. 4
4	AAC valve control signal	14	Engine A/T control input signal (DT2)(A/T)
5	Engine A/T control input signal (DT1)(A/T)	15	Engine A/T control input signal (DT3)(A/T)
6	-	16	ECCS relay
7	Engine rev signal for tachometer	17	Injection pulse (Ti monitor) signal
8	-	18	Fuel pump relay
9	Air conditioner relay (A/C cut signal)	19	Power steering oil pressure SW signal
10	Earth (Ignition signal system)	20	Earth (Ignition signal system)
21(RX)	Receive (C/U data reception)	31(CLK)	Clock (synchronized signal)
22(TX)	Transmit (Data to C/U)	32	Engine warning lamp
23	Knock sensor signal 1 (Cyl. 1-3)	33	Exhaust temperature warning lamp
24	Knock sensor signal 2 (Cyl. 4-6)	34	-
25	Boost control solenoid sig (RB25DET only)	35	-
26	Air flow meter earth	36	-
27	Air flow meter intake air quantity signal	37	-
28	Engine coolant temperature sensor signal	38	Throttle sensor opening signal
29	Exhaust gas sensor signal	39	-
30	Earth (Sensor signal system)	40	-
41	Crank angle sensor 120° signal (REF sig)	51	Crank angle sensor 120° signal (REF sig)
42	Crank angle sensor 1° signal (POS sig)	52	Crank angle sensor 1° signal (POS sig)
43	Key SW START signal	53	Vehicle speed sensor
44	Neutral SW	54	-
45(IGN)	Key SW IGN signal	55	-
46	Air conditioner SW signal	56	Throttle opening output signal
47(CHK)	Check (diagnosis)	57	Exhaust temperature sensor signal
48	Throttle sensor power	58	Battery power
49	C/U power	59	C/U power
50	C/U earth	60(-)	C/U earth
101	Injector No.1	109	Inverse current feedback circuit
102	-	110	Injector No.5
103	Injector No.3	111	-
104	Fuel pump terminal power control output signal (FPCM)(RB25DET only)	112	Injector No.6
105	Injector No.2	113	Variable valve timing solenoid
106	-	114	Injector No.4
107	Injector ground	115	Exhaust gas sensor heater ground
108	Injector ground	116	Injector ground

ENGINE AND EMISSION CONTROL OVERALL SYSTEM

Circuit Diagram

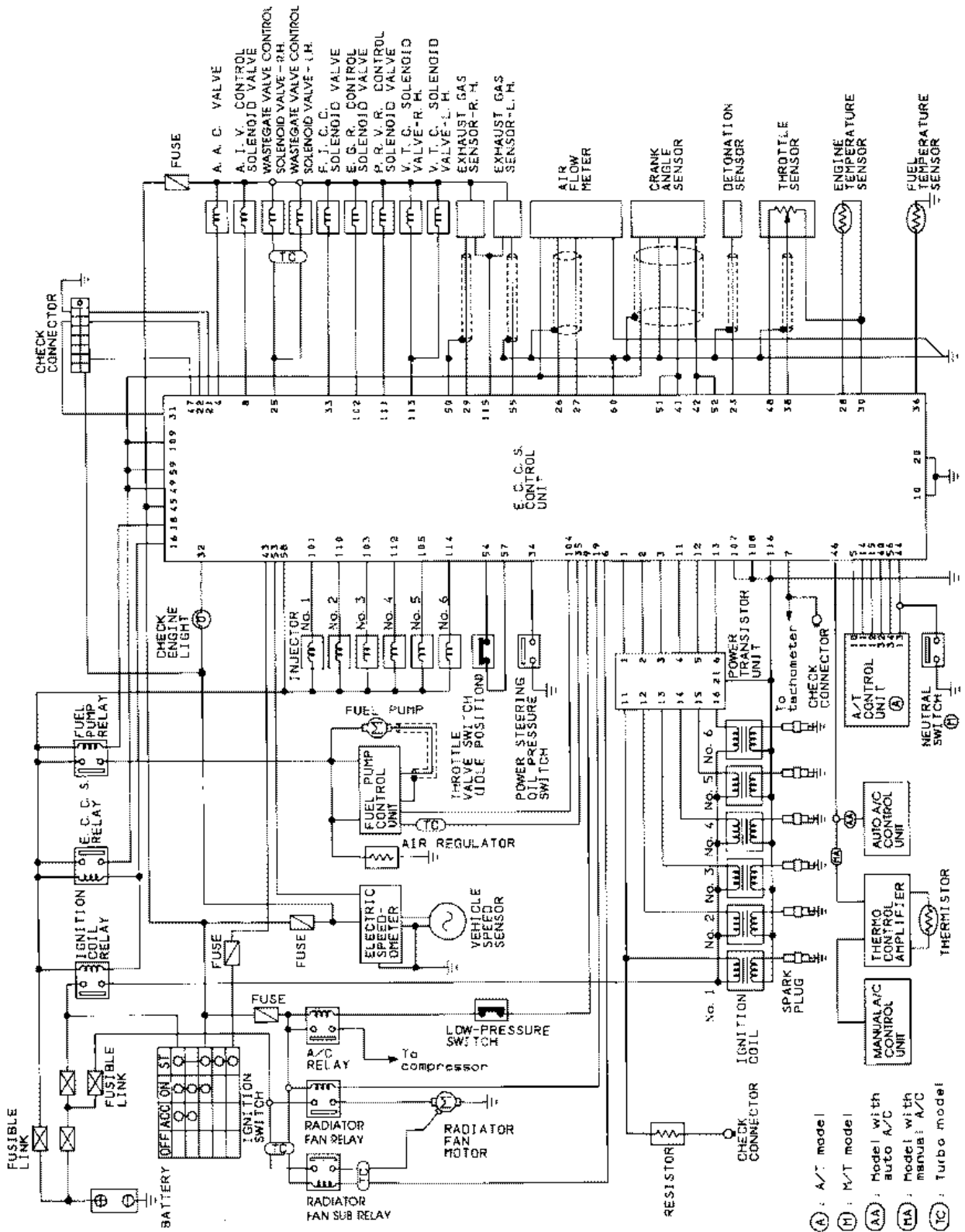

RB25DE / RB25DET ENGINE

1. CIRCUIT DIAGRAM (RB25DE / RB25DET)

