

AVC-D

ACTUATOR VALVE CONTROLLER TYPE-D

INSTRUCTION MANUAL

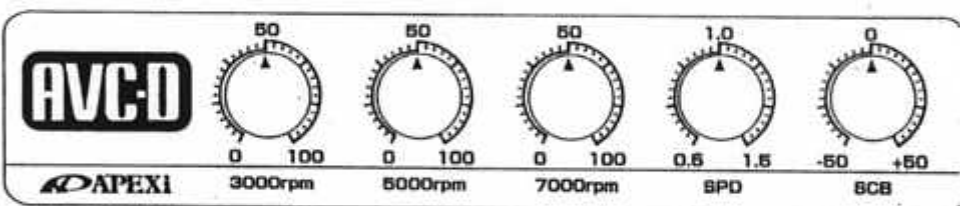

 **APEXi**

Please be sure to read this before attempting installation or operation.

Thank you for purchasing the AVC-D

- * In order to properly use this unit, please be sure to read this instruction manual carefully.
- * Please store this manual inside of the vehicle for reference.
- * Please be sure to include this manual with the unit when selling.

Product Name: AVC-D

Product Code: 420-A003

Applications: 3,4,6,8 Cylinder Electronically Fuel Injected Gasoline Turbo Engines.

Function : Boost control for turbocharged vehicle engines.

Note1:

A separate wiring harness and MOMENTARY TYPE BUTTON SWITCH (the type of switch that turns ON only when depressed) must be purchased when using the scramble boost feature.

Note2:

Twin turbo, External Wastegate, and Sequential Twin Turbo vehicles requires additional parts which are NOT included in this product.

Note3:

This unit CANNOT control Fuel Cut problems that may occur through raising boost levels. An additional fuel cut controller may become necessary.

Note4:

When raising boost, please make sure that all engine components and related management parts can withstand the increase cylinder pressures.

To Begin

Thank you for purchasing the AVC-D.

In order to properly use this unit, please read this instruction manual carefully.

This product controls the movement of the internal (swing valve) and external (poppet) wastegates to allow control of boost pressure.

By using the click style knobs on the face of the unit, the user can manipulate boost levels in a MANUAL and DIRECT fashion.

Features

- 1) can set boost at 3000, 5000, and 7000 RPM
- 2) The main boost levels can be raised or lowered under low speed load (when the vehicle speed is low) by inputting a vehicle speed signal.
- 3) The main boost levels can be raised or lowered for a set amount of time by adding a scramble boost switch.
- 4) The unit can handle boost pressures beyond 2.0 kg/cm² because it does NOT use a pressure sensor.

- * This unit DOES NOT use a feedback system and DOES NOT include a "self learning" function. Although there are no complicated initial calibrations, BOOST OVERSHOOT may occur depending upon the application vehicle and desired boost levels. The boost overshoot will require the user to set the boost levels with this in mind. This unit should be tuned only by an experienced professional tuner.
- * This unit does NOT include a boost level display monitor. An external boost gauge MUST be added to read the boost levels.

-
- * Please be sure to double check the contents list (refer to page 5) for any missing or damaged parts. Please contact your dealer of purchase if there is anything missing or damaged.
 - * This manual is intended to allow the user to properly operate this unit in a responsible fashion.
 - * Please contact your dealer of purchase or our office to re-order missing parts or manuals.
 - * THIS PRODUCT IS DESIGNED FOR OFF-ROAD RACE PURPOSES ONLY. This may never be used upon a public highway for any reasons.
 - * THIS PRODUCT HAS BEEN ENGINEERED TO WORK ON FACTORY SPECIFICATION VEHICLES. Installation and use of this product for any other purposes than specified within this instruction manual will VOID all warranties expressed or implied.
 - * A'PEX is not responsible for any damages resulting from improper installation or use of this product by the customer or any third party.
 - * Please be sure that the warranty card and serial number on the unit match correctly. A'PEX will not warranty any products where the serial numbers do not match.
 - * This product is engineered for any vehicle with a 12 V power source with a negative ground..
 - * A'PEX reserves the right to change the contents, function, price, and appearance of this product without prior notification.
 - * A'PEX reserves the right to change this instruction manual without prior notification.
 - * Please be sure to give this instruction manual and warranty card to the user after installation.
 - * This product is designed for the Japanese market only.
- If it is used in another country, be aware that some vehicle specifications are different..
-

Table of Contents	
To Begin	1
Table of Contents	2
Glossary	2
Safety Precautions	3,4
Parts List	5
Product Features (Diagram/ Function)	6
Installation	7
Installation Preparation	7
Connection Diagram	8
Wiring Procedure	8
Connection of the Electrical and Signal Harness	8
Wiring Diagram	9
Scramble Boost Switch (sold separately) Connection Diagram	9
Control Unit Setting	10
Vehicle Specific Application Table	11
TOYOTA 11/ NISSAN 11,12/ MITSUBISHI 12/	
MAZDA, SUBARU, SUZUKI, DAIHATSU 13	
Vehicle Specific Computer Location Diagram	14
Vehicle Specific Computer Wiring Diagram	15
TOYOTA 15,16/ NISSAN 16/ MITSUBISHI 17/	
MAZDA 18/ SUBARU 19/ SUZUKI,DAIHATSU 20	
Hosing Diagram	21
Actuator Type (Internal) Wastegate Hosing Diagram	21
Poppet Type (External) Wastegate Hosing Diagram	22
Actuator Type (Internal) Vehicle Specific Hosing Diagram	23
Vehicles with Factory Boost Control Solenoid Valves 1	23
Vehicles with Factory Boost Control Solenoid Valves 2	24
JZA80/ JZS 147 Hosing Diagram	25
FD3S Hosing Diagram	26
BD5/ BG5 Hosing Diagram	27
CN9A Hosing Diagram	28
EC5A/ EC5W Hosing Diagram	29
Mounting Instructions	30
Checkpoints after Installation	30
Operation and Setting Instructions	31
RPM Specific Setting Example	31
Vehicle Speed Correction Setting Example	31
Scramble Setting Example	32
About the Knob Illumination	32
Duty Setting Tips for Various Settings	32
About the Optional Parts ,In Case of Product Malfunction, Product Specifications,	33

Glossary

- * This instruction manual is intended to help the user install this product safely and without harm to others. It is written with the intent that the user will be able to properly utilize all of the functions contained within this unit. The glossary list is below. Please be sure you understand the proper definition of each key word before proceeding with the installation.

KEY WORD	DEFINITION
⚠ DANGER	Failure to obey this warning will likely result in DEATH or severe injury to the user.
⚠ WARNING	Failure to obey this warning may cause DEATH or severe injury to the user.
⚠ CAUTION	Failure to obey this warning may result in light injury to the user, product damage, or damage to the surrounding area.
NOTES	Failure to obey this warning may result in product failure or inability to use all of the functions of this product.

Safety Precautions

⚠ WARNING

- * Please discontinue use of the AVC-D if you hear a burning noise or smell a burning scent. Kindly repack the unit with all of the original material and take it back to the place of purchase or to the nearest sales office.
Continued use under these conditions may result in electrical shorts, electrical fires, or electrical damage to the product and vehicle.
- * Never operate the unit while driving. Using any of the functions other than monitoring may result in injury or accidents.
- * Securely mount this unit and keep it away from any areas which might get in the way of driving. Failure to do so may result in injury or accidents.
- * This unit is designed only for DC12V type vehicles with a negative ground. Do not install this unit on any other type of vehicle. Failure to do so may result in vehicle fire.
- * Be sure to disconnect the negative terminal of the battery before proceeding with installation. Failure to do so may result in vehicle fire, electrical shortage, electrical system damage, and product damage.
- * Be sure to securely hold the connector when disconnecting. Failure to do so may result in vehicle fire, electrical shortage, electrical system damage, and product damage.

⚠ CAUTION

*** INSTALLATION OF THIS PRODUCT SHOULD BE PERFORMED BY AN EXPERIENCED INSTALLER OR TUNER.**

*** Never modify, change, or disassemble this unit.**

*** Please do not expose this unit to excessive shock.**

*** ALWAYS DOUBLE CHECK FOR: incorrect wiring and hosing, electrical short, exposed wires, faulty connections, and cut wires.**

*** Do not expose this unit to water or high temperatures.**

This could lead to electrical shock, vehicle fire, and engine damage.

Incorrect operation could cause engine damage.







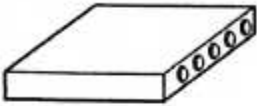
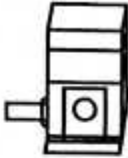

*** When raising boost levels, please be sure to confirm that the engine and fuel injection system can withstand the raised boost levels.**

Exceeding the allowable levels of boost may cause severe engine and turbocharger damage.

*** Do not set the boost level beyond the turbocharger capacity.**

Exceeding the turbocharger capacity for boost may cause turbocharger damage which could also cause internal engine damage.

Parts List

1. Control Unit	2. Solenoid Valve	3. Harness
	 <p data-bbox="573 212 681 375"> "NO" = Normally Open "NC" = Normally Close "COM" = Common </p>	
1	1	1
4. Taps	5. Hose	6. Hose clamps
		
4	6φ 1	6φ 4
7. Protective Rubber Mount for Solenoid Valve	8. Solenoid Valve Mounting Bolts	9. Double-sided Tape
		
1	M5 4	1
10. Instruction Manual	※ Optional Parts List is on Page 33	
		
1		

Product Features (Diagrams / Functions)

Front Panel

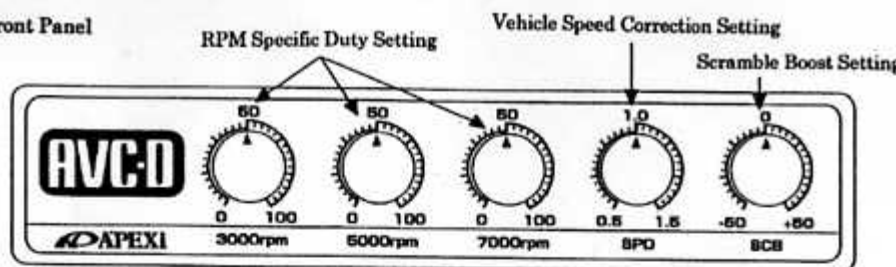

Rear Panel

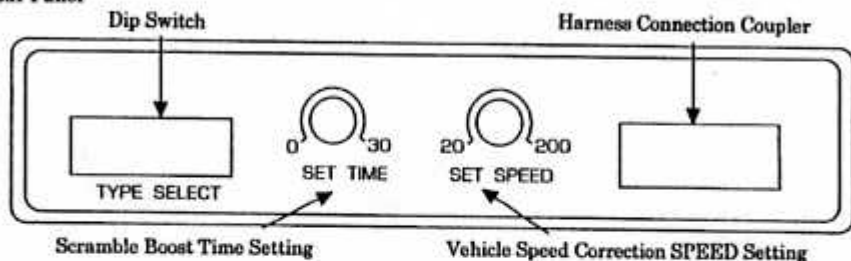

• RPM Specific Duty Setting

Volume settings for base duty at 3000,5000,7000rpm

When: VOLUME is set to "0"

Then: Factory Actuator/ Wastegate setting

When: VOLUME is set to "100"

Then: Unlimited Boost / No wastegate control

• Vehicle Speed Correction Setting Volume

Allows correction of 0.5-1.5 times the base duty cycle

(The vehicle speed correction setting will not operate when the base duty cycle is set to "0"

• Vehicle Speed Correction SPEED Volume

Allows vehicle speed correction SPEED to be set between 20-200km/h.

• Scramble Boost Setting Volume

Allows -50%--+50% adjustment of base duty cycle during scramble boost

• Scramble Boost Time Setting Volume

Sets the scramble boost time from 0-30 seconds

• Dip Switch

Set according to application vehicle for speed correction function

• Harness Connection Coupler

For connection of Harness

Installation

Installation Preparation

1) THE FOLLOWING TOOLS ARE NECESSARY FOR INSTALLATION

Please be sure to prepare these items before installation.

Pliers, Box Wrenches, Screwdrivers, Socket wrenches, wire strippers, electrical tape, zip ties, precision screwdriver, wire cutters, and crimper.

- * A **MOMENTARY** type button switch is necessary to use the scramble boost feature. Please use a **MOMENTARY** button or toggle (ie. Horn button style). These switches **ARE NOT INCLUDED WITH THIS UNIT**.
- * Please prepare a 3 WAY joint and hose clamp that matches the actuator size when installing this unit on a twin turbo vehicle. **THESE ITEMS ARE NOT INCLUDED IN THIS UNIT**. Optional parts number (430-A001 Twin Turbo Installation Parts)
- * A hoseclamp/ 3 WAY/ and PT nipple matching the external wastegate specifications will become necessary when installing the unit on an external wastegate vehicle. These items **ARE NOT INCLUDED IN THIS UNIT**. Optional parts number (430-A002 External Wastegate Installation Parts)
- * A $\frac{1}{8}$ transition nipple for the actuator is necessary when installing this unit on an EJ20 sequential twin turbo engine. This item **IS NOT INCLUDED IN THIS UNIT**. (430-A001 Twin Turbo Installation Parts)

2) Be sure to disconnect the negative terminal of the battery before installation.

All stored data from other electrical products will be erased when the battery is disconnected. We recommend taking note of all preset values for when the battery is reconnected.

WARNING

- * Please be sure to disconnect the negative terminal of the battery before installation. Failure to do so may result in engine fire, electrical shorts, and electrical product damage.

3) Be sure to check all vehicle wiring and vacuum hoses **BEFORE** starting installation. Make sure that the vehicle diagrams are the same as the actual vehicle wiring.

CAUTION

- * Avoid incorrect hosing, wiring, connections, hose sizes, and electrical shorts during installation. This may lead to electrical shorts, and engine fire which may damage electrical products. Product failure may also lead to vehicle engine damage.

4) Be sure that the vehicle **IS CAPABLE OF HANDLING INCREASED BOOST PRESSURE LEVELS BEFORE INSTALLING THE UNIT**.

CAUTION

- * When raising boost levels, please be sure to confirm that the engine and fuel injection system can withstand the raised boost levels. Exceeding the allowable levels of boost may cause severe engine and turbocharger damage.

Connection Diagram

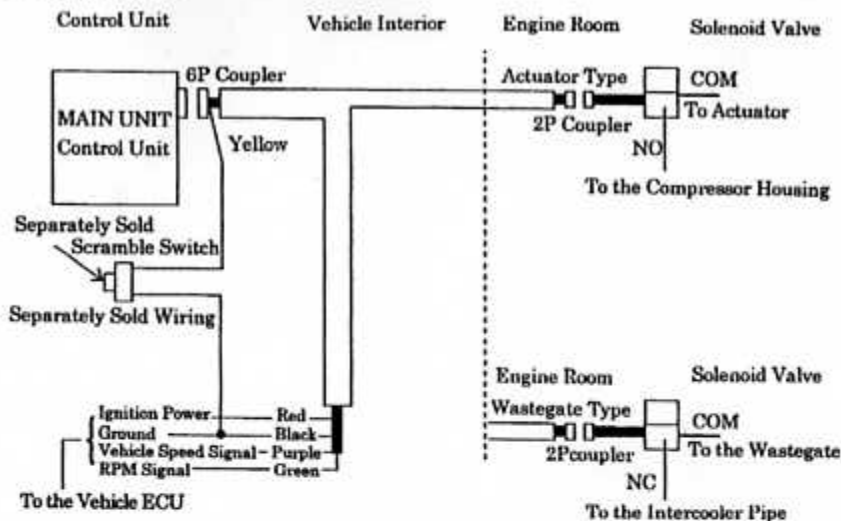

Wiring Procedure

Connection of Electrical and Signal Harnesses

- 1) Disconnect the negative terminal of the battery.
- 2) Refer to the diagram above to bring the 6P harness and ECU Connection harness into the vehicle cabin. If there is no available hole in the firewall, please make one. Be sure to cover the exposed edges of the new hole with a protective rubber seal to prevent cutting the electrical wires and causing electrical shorts and damage to the harness.
- 3) Locate the vehicle ECU using the Vehicle Specific Wiring Diagram and Vehicle Specific Computer Location diagram.
- 4) Use the Vehicle Specific Wiring Diagram to connect the power, ground, and other signal wires to the ECU by SECURELY fastening the included wire Taps.

Red Wire- Connect to IG (Ignition) power

Black Wire- Connect to ECU ground

Purple Wire- Connect to Vehicle Speed Signal Wire

Green Wire- Connect to RPM Signal Wire

- 5) Make sure that all connections made insulated in step (4) with electrical tape.

* How to use the Taps

- 1) Strip away 3mm from the wire



- 2) Strip 5mm away from the connection wire

* Use electrical tape to securely protect the connection

- 3) Intertwine the two wires



- 4) Securely fasten both wires



Wiring Diagram

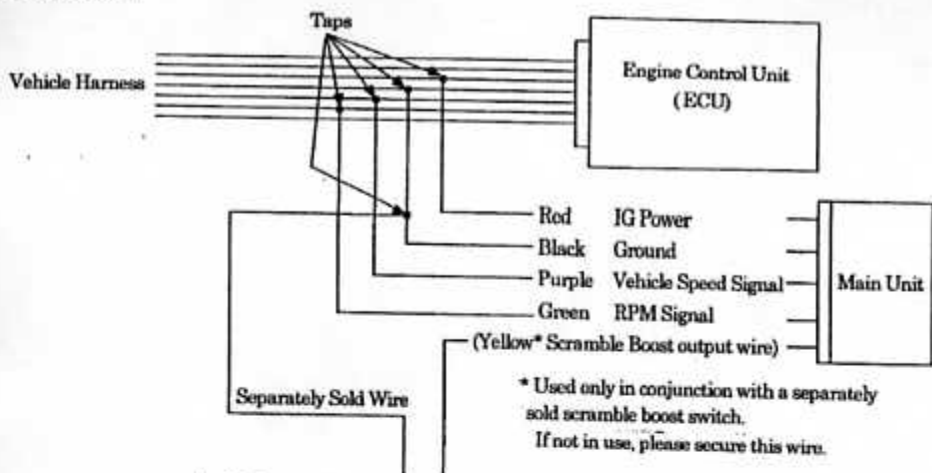

To the Separately Sold Scramble Boost Switch (Basic Wiring Method)

Please refer to the scramble boost switch connection on page 9 for detailed connection diagrams

Scramble Boost Switch (Sold Separately) Connection Diagram.

By adding a momentary type switch (button or toggle) to the unit, the user can either raise or lower the boost levels for a preset amount of time.

Please purchase a non-locking PUSH style switch or a level style non-locking switch.

Wiring Diagram

Button pops back up immediately after being depressed

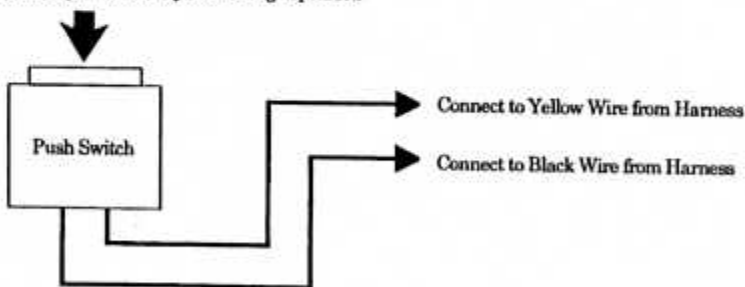

Lever pops back up immediately after being depressed

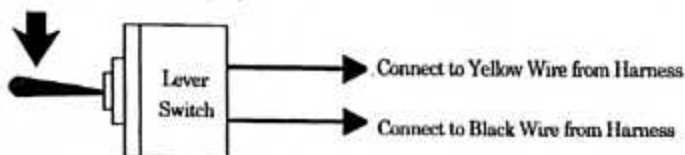

Control Unit Setting

Use the dipswitches on the rear panel of the unit to select cylinder type and vehicle speed pulse type.

BE SURE TO REFER TO THE DIAGRAM BELOW WHEN SETTING

(All switches are in the OFF position out of the factory.)

Setting Example

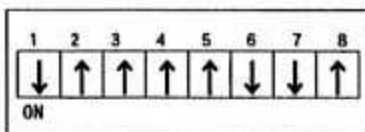

The example above shows 4 cylinder/ vehicle speed 2 Pulse type/ scramble switch setting (ground style)

Dip Switch Setting Diagram

Switch Number	1	2		3	4		5		6	7	8
Cylinder Number			Vehicle Pulse Setting			Leave in the OFF Position		Scramble Switch Setting			
3 Cylinder	↑	↑	2 Pulse	↑	↑	Leave in the OFF Position	↑	Ground Connection (Standard Connection)	↓	↓	↑
4 Cylinder	↓	↑	4 Pulse	↓	↑						
6 Cylinder	↑	↓	8 Pulse	↑	↓			Power Connection (+12 V Signal)	↑	↑	↓
8 Cylinder	↓	↓	16 Pulse	↓	↓						

* About the Cylinder Setting

For rotaries, please take the number of rotors X 2

* About Vehicle Speed Pulse

The NISSAN Y32 Cedric, Gloria, and CIMA are 16 Pulse. All other NISSAN vehicles are 2 Pulse. All other Japanese vehicles are 4 Pulse.

Vehicle Specific Application Table
Vehicle Specific Computer Wiring Diagram

TOYOTA

Vehicle Name	Model Type	Engine	Year	ECU Location	ECU Wiring	Note
Arist	J Z S 1 4 7	2 J Z - G T E	'91.10-'97.8	c	T 2	
Soarer	J Z Z 3 0	1 J Z - G T E	'91.5~	c	T 3	
	M Z 2 0	7 M - G T E	'89.1-'91.4 '86.1-'88.12	d	T 6 T 9	
	G Z 2 0	1 G - G T E	'89.1-'91.4 '86.1-'88.12		T 6 T 1 0	
	Supra	J Z A 8 0	2 J Z - G T E	'93.5-'97.8	c	T 2
J Z A 7 0		1 J Z - G T E	'90.8-'93.4	d	T 5	
MA 7 0		7 M - G T E	'88.8-'90.7 '86.1-'90.7		T 6	turbo A
GA 7 0		1 G - G T E	'88.9-'93.4 '86.2-'88.8		T 6 T 9	
Mark II Chaser Cresta	J Z X 1 0 0	1 J Z - G T E	'96.9~		e	T 3
	J Z X 9 0		'92.12~'96.8			
	J Z X 8 1		'90.8-'92.9	d	T 5	
	G X 8 1	1 G - G T E	'88.8-'90.8		T 6	
MR 2	SW 2 0	3 S - G T E	'89.10~	Trunk	T 6	
Celica	ST 2 0 5	3 S - G T E	'94.2~	e	T 6 T 1 0	
	ST 1 8 5		'89.10-'93.9			
	ST 1 6 5		'85.8-'89.9			
Starlet	EP 9 1	4 E - F T E	'95.12~	d	T 7	
	EP 8 2		'89.12~'95.12 '92.1~'95.12	e	T 8 T 7	M/T A/T
	EP 7 1		2 E - T E		'86.1-'89.12	T 1 2

NISSAN

Vehicle Name	Model Type	Engine	Year	ECU Location	ECU Wiring	Note
Cima	FHY 3 3	VQ 3 0 D E T	'96.6~	a	N 1	
	FPY 3 2	VG 3 0 D E T	'93.9-'93.6		N 1	
	FPY 3 1		'89.8-'91.7 '88.1-'89.7		N 6	
	Fairlady 2		Z 3 2			VG 3 0 D E T
Leopard	Z 3 1	VG 3 0 D E T RB 2 0 D E T	'86.10-'89.7	a	N 5	
	JHY 3 3	VQ 3 0 D E T	'96.3~	a	N 4	
UF 3 1	VG 3 0 D E T	'88.8-'92.6	N 1			
Gf 3 1	VG 2 0 D E T		N 6			
Cedric Gloria	Y 3 3	VQ 3 0 D E T	'95.6~	a	N 4	
	Y 3 2	VG 3 0 D E T	'91.6-'95.6		N 1	
	Y 3 1	VG 2 0 D E T	'89.8-'91.6			

Cefiro	A 3 1	RB 2 0 DET	'88.9-'94.8	a	N 1	
Laurel	C 3 4	RB 2 5 DET	'94.1-'97.6	a	N 1	
	C 3 3	RB 2 0 DET	'89.1-'93.1			
Skyline	R 3 3	RB 2 6 DET	'95.1-	a	N 1	
		RB 2 5 DET	'93.8-			
	R 3 2	RB 2 6 DET	'89.8-'95.1			
		RB 2 0 DET	'89.5-'93.8			
R 3 1	RB 2 0 DET	'87.8-'89.5		N 5		
Stagea	WC 3 4	RB 2 5 DET	'96.8-	a	N 7	
Bluebird	U 1 3	SR 2 0 DET	'91.9-'96.1	e	N 2	
	U 1 2	SR 2 0 DET	'89.10-'91.9			
		CA 1 8 DET	'87.9-'89.10			N 1
Silvia	S 1 4	SR 2 0 DET	'96.6-	a	N 2	
			'93.10-'96.6		N 1	
	PS 1 3		'91.1-'93.10		N 3	
	S 1 3	CA 1 8 DET	'88.5-'91.1		N 1	
1 8 0 S X	RPS 1 3	SR 2 0 DET	'96.8-	a	N 2	
			'91.1-'96.6		N 3	
	RS 1 3	CA 1 8 DET	'89.3-'91.1		N 1	
Pulsar	N 1 4	SR 2 0 DET	'90.8-'95.1	e	N 2	
Avenir	W 1 0	SR 2 0 DET	'95.8-	e	N 2	

MITSUBISHI

Vehicle Name	Model Type	Engine	Year	ECU Location	ECU Wiring	Note
GTO	Z 1 6 A	6 G 7 2	'90.10-	e	M 3	
Galant	EC 5 A	6 A 1 3	'96.8-	e	M 1	
	E 8 4 A	6 A 1 2	'92.5-'96.8		M 3	
	E 3 9 A	4 G 6 3	'87.10-'92.4	b	M 2	
Legnan	EC 5 W	6 A 1 3	'96.8-	e	M 1	
Eclipse	D 3 2 A	4 G 6 3	'95.6-'	e	M 1	
	D 2 7 A		'89.11-'95.6		M 4	
Lancer (Mirage)	CM 5 A	4 G 9 3	'95.10-	b	M 1	
	CN 9 A	4 G 6 3	'96.8-		M 1	
	CE 9 A		'93.10-'95.10		M 3	
	CD 9 A		'92.10-'93.10			
	CD 5 A		4 G 9 3			'91.10-'95.10
Libero	CD 5 W	4 G 9 3	'94.1-'95.10	b	M 3	
RVR	N 2 3 W	4 G 6 3	'94.10-	b	M 3	
Pajero Mini	H 3 6 A	4 A 3 0	'93.9-	j	M 6	
Mintca Dengan	N 2 3 W	4 A 3 0	'93.9-	j	M 8	

MAZDA

Vehicle Name	Model Type	Engine	Year	ECU Location	ECU Wiring	Note
Cosmo	JCES	20B-REW	'90.3-'95.8	c	Z 1	
	JC3S	13B-REW				
RX-7	FD3S	13B-REW	'95.12~	a	Z 2	
			'91.12-'95.12			
	FC3S *	13B	'88.9-'91.12	c	Z 3	
			'85.10-'88.9			Z 4

* Only for FC3S with Crise Control (location is "h")

SUBARU

Vehicle Name	Model Type	Engine	Year	ECU Location	ECU Wiring	Note
Legacy	BD5 BG5	EJ20R	'96.6~	c	F 5	
		EJ20H(MT)				
		EJ20H(AT)				
		EJ20H	'93.10-'96.6		F 1	
	BC5 BF5	EJ20G	'89.2-'93.10	h	F 2	
Impreza	GCB	EJ20G	'92.11-'96.9	c	F 2	
	GF8		'93.10-'96.9			
	GCB, GF8	EJ20K	'96.9~	c	F 5	
	GF8	EJ20G				

SUZUKI

Vehicle Name	Model Type	Engine	Year	ECU Location	ECU Wiring	Note
Alto Works	HA21S	K6A	'94.11~	b	S 1	
	HB21S					
	HA11S	F6A			S 2	
	HB11S					
Capuchino	EA21R	K6A	'95.5~	k	S 3	
	EA11R	F6A	'91.11-'95.5	b	S 4	
Wagon-R	CT21S	F6A	'95.11~	b	S 5	MT
	CV21S				S 6	AT
	CT21S		'93.9-'95.11		S 4	MT
	CV21S					

DAIHATSU

Vehicle Name	Model Type	Engine	Year	ECU Location	ECU Wiring	Note
Mira TR-XX	L502S	JB-JL	'94.9~	d	D 1	
	L512S					
	L500S					EF-JL
	L602S	JB-JL	'95.8~			

Vehicle Specific Location Diagram

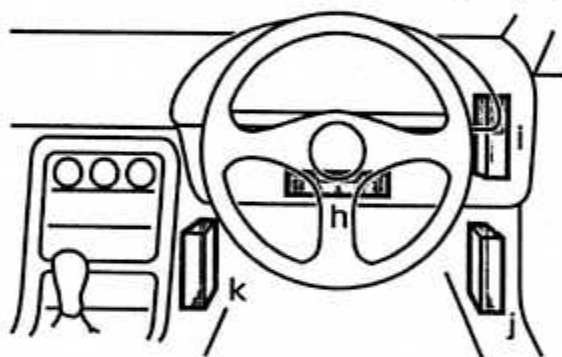
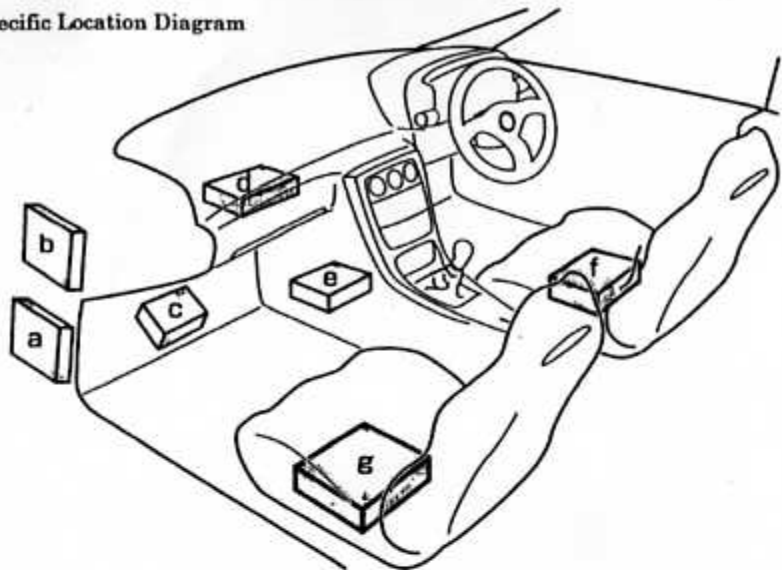

- a Passenger Side Lower Dash
- b Left of the Glove Box
- c Passenger Side Foot Rest
- d Behind the Glove Box
- e Behind the Center Console
- f Under the Driver Seat
- g Under the Passenger Seat
- h Near the Steering Column
- i Right of the Meter Panel
- j Driver Side Lower Dash
- k Right of the Center Console

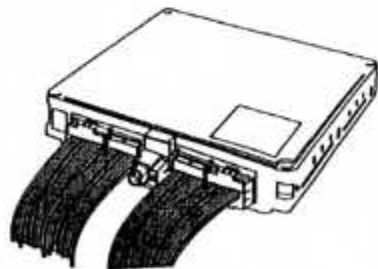
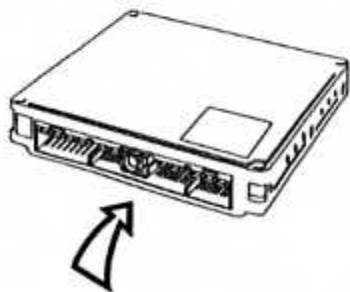

View the Vehicle Specific Wiring Diagram FROM THIS ANGLE.

Some vehicles may have the computer unit mounted backwards. Please be sure to count the number of pins before proceeding with installation.

車種別コンピュータ配線図

TOYOTA

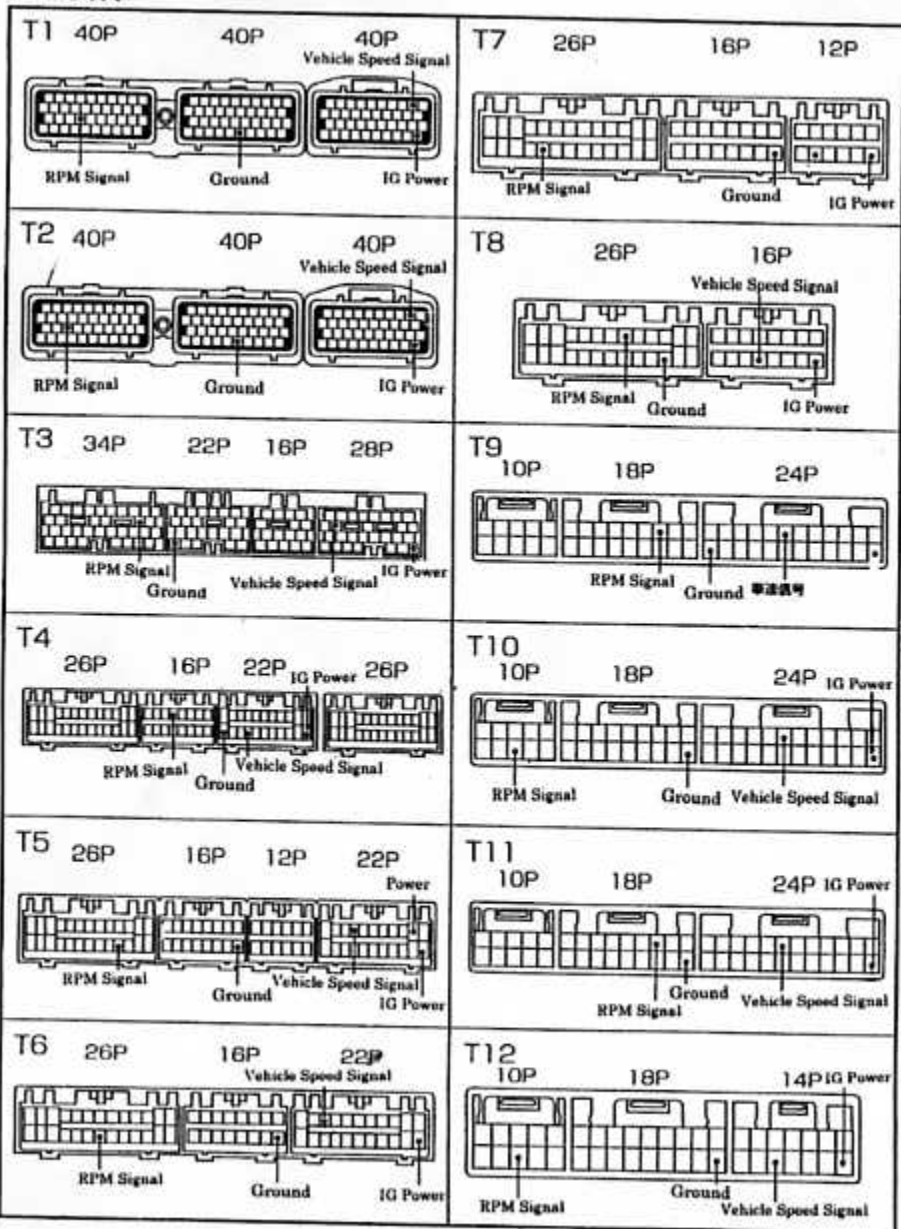

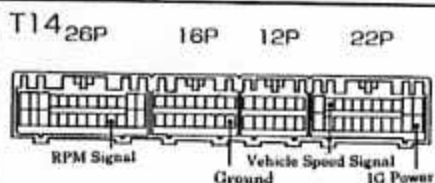
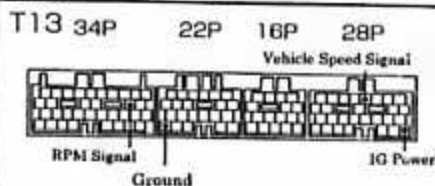

NISSAN

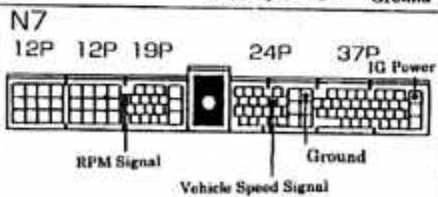
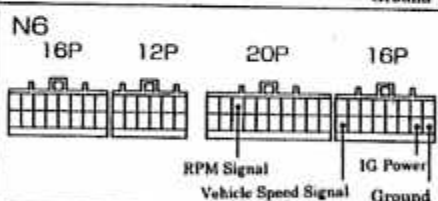
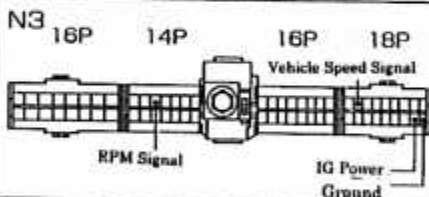
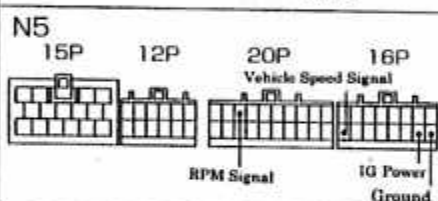
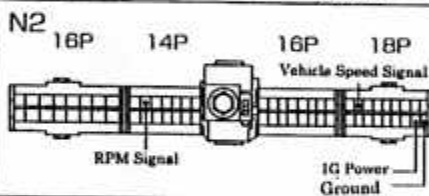
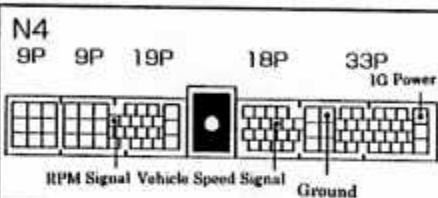
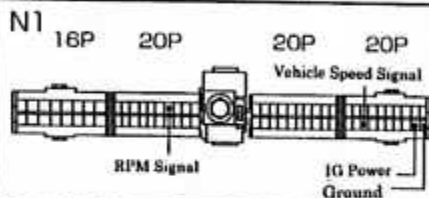

MITSUBISHI

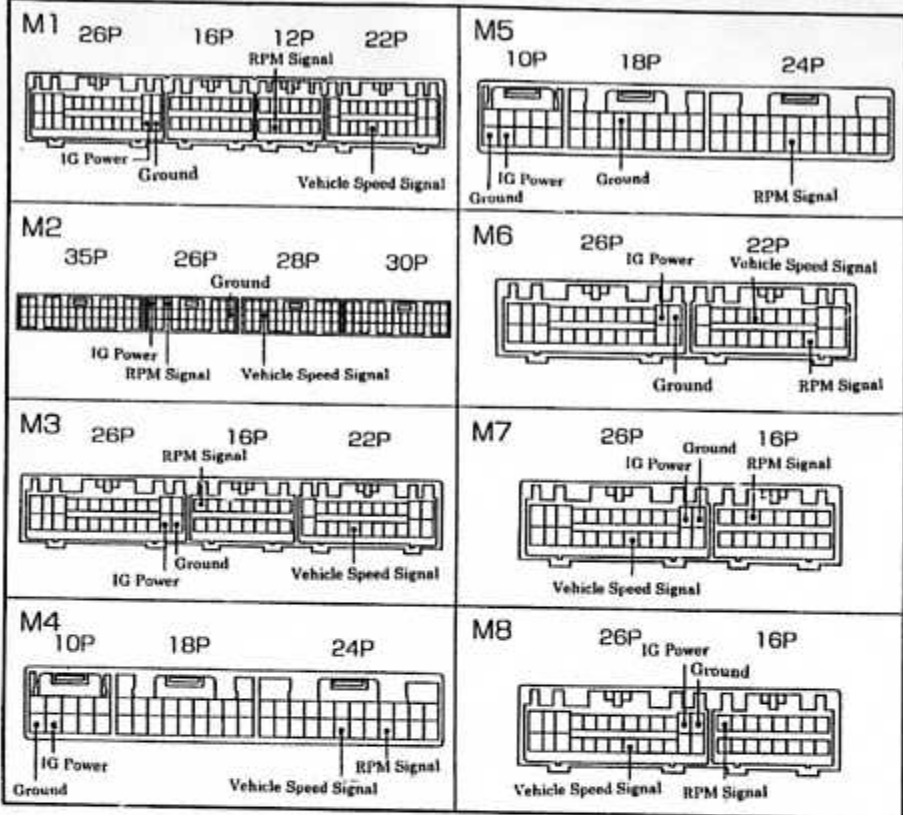

MAZDA

Z1 26P 16P 12P 22P

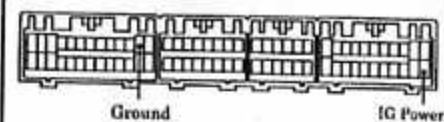

• Engine RPM signal : from EC-AT(Z5)

Z2 26P 16P 12P 22P

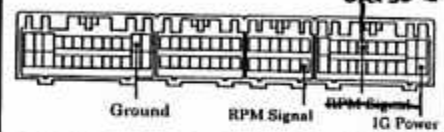

Z3 26P 16P 22P

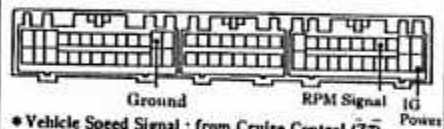

• Vehicle Speed Signal : from Cruise Control (Z7)

Z4 10P 18P 24P

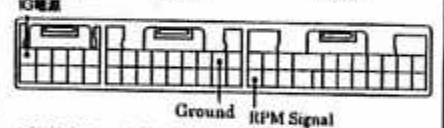

• Vehicle Speed Signal : from Cruise Control (Z6)

Z5 20P 16P

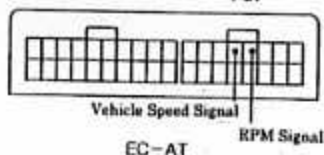

Z6 13P

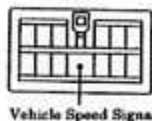

• Vehicle Speed Signal : from Cruise Control

Z7 18P

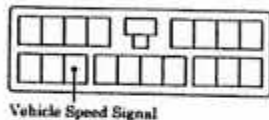

• Vehicle Speed Signal : from Cruise Control

Z8 IG Power 34P 22P 26P

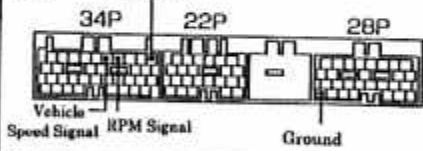

SUBARU

F1 26P 16P 12P 22P

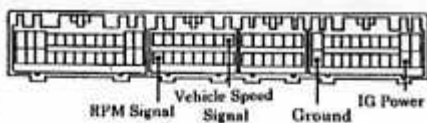

F4 26P 16P 22P
IG Power Ground Vehicle Speed Signal

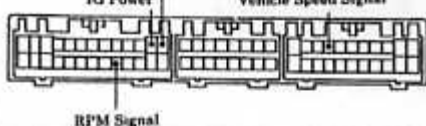

F2 26P 16P 12P 22P

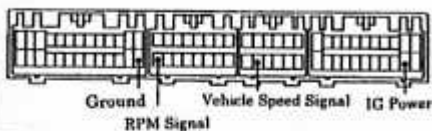

F5 26P 16P 22P
Vehicle Speed Signal

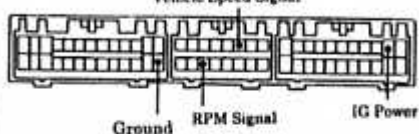

F3 26P 16P 22P

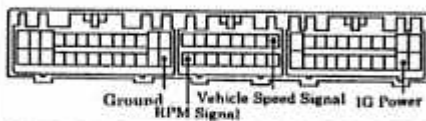

F6
IG Power

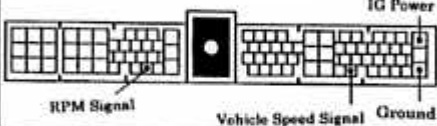

SUZUKI

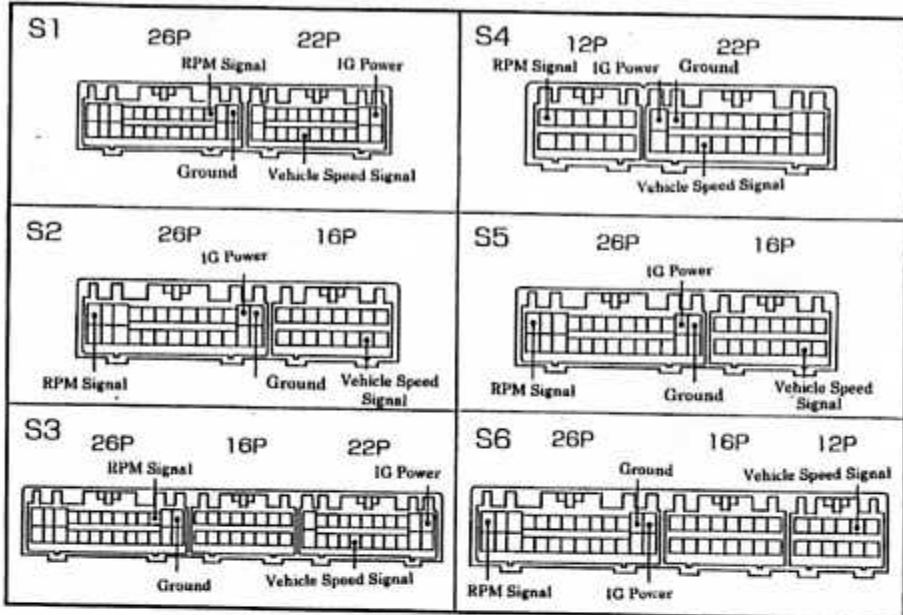

DAIHATSU

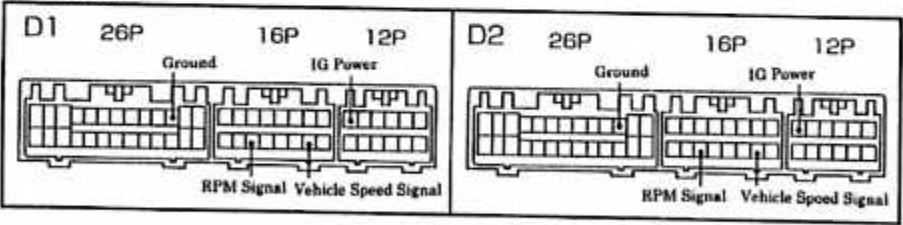

Hosing Diagram

Actuator Type (Internal Wastegate) Hosing Diagram

- 1) Disconnect the hose going from the compressor housing of the turbo to the actuator
- 2) Cut the included 6 pi hose to the required length
- 3) Using the diagram below, connect the compressor housing to the NO port of the solenoid valve.
- 4) Using the diagram below, connect the actuator side to the COM port of the solenoid valve.
- 5) Leave the NC port of the solenoid valve open atmosphere
- 6) Mount the solenoid valve away from high temperatures in a position where the harness can reach. Use the rubber mounting plate when mounting the solenoid valve.

⚠ CAUTION

- Do not mount the solenoid valve near high temperatures or without the protective rubber base. Failure to do so may result in shortened solenoid valve lifespan which may cause engine and turbocharger damage.

- 7) Be sure to connect hose clamps to all vacuum hoses to ensure secure connections. Please check for bent or kinked vacuum hoses.

⚠ CAUTION

- Be sure to secure ALL vacuum hoses to prevent accidental blow off. Vacuum hoses that blow off during driving may cause extensive engine and turbocharger damage.

⚠ CAUTION

- Some vehicles have a factory boost pressure solenoid valve. Please be sure not to connect the factory solenoid valve with this unit. Connecting the factory boost pressure solenoid valve will prevent proper boost control and will cause engine and turbocharger damage.

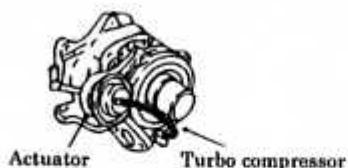

Factory Vehicle Hosing Diagram

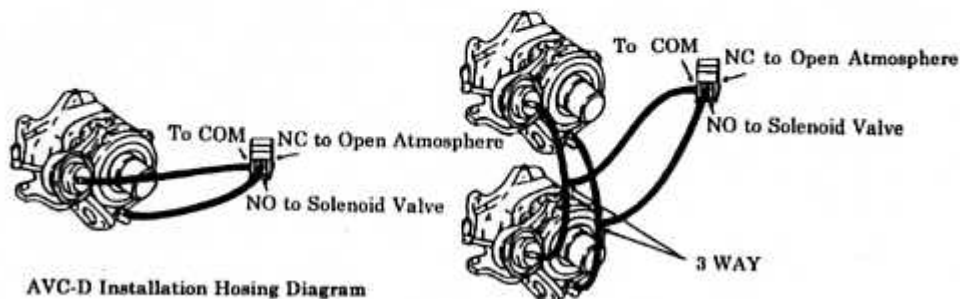

AVC-D Installation Hosing Diagram

Twin Turbo Hosing Diagram

Poppet Type (External Wastegate) Hosing Diagram

- 1) Connect a metal 6 pi fitting on to the top port of the wastegate. (This 6 pi fitting is NOT included in our unit. Please purchase this item separately.)
 - * Use a sealant when screwing the fitting on to the wastegate.
- 2) Remove the nipple on the NO side of the solenoid valve and attach it tot he NC side of the solenoid valve
 - * Use a sealant when screwing the fitting on to the wastegate.
- 3) Leave the NO open atmosphere
- 4) Connect the 8 pi-6pi-8pi 3 WAY to the 8 pi hose going from the surge tank to the bottom port of the wastegate.
(This 8pi-6pi-8pi 3 WAY is not included in this unit. Please purchase this item separately.)
- 5) Connect a 6 pi hose to the 8pi-6pi-8pi 3 WAY and connect this to the NC nipple of the solenoid valve.
- 6) Connect a 6 pi hose between the COM nipple of the solenoid valve and the top port of the wastegate from step (1.)
- 7) Mount the solenoid valve away from high temperatures in a position where the harness can reach. Use the rubber mounting plate when mounting the solenoid valve.

⚠ CAUTION

* Do not mount the solenoid valve near high temperatures or without the protective rubber base. Failure to do so may result in shortened solenoid valve lifespan which may cause engine and turbocharger damage.

- 8) Be sure to connect hose clamps to all vacuum hoses to ensure secure connections. Please check for bent or kinked vacuum hoses.

⚠ CAUTION

* Be sure to secure ALL vacuum hoses to prevent accidental blow off. Vacuum hoses that blow off during driving may cause extensive engine and turbocharger damage.

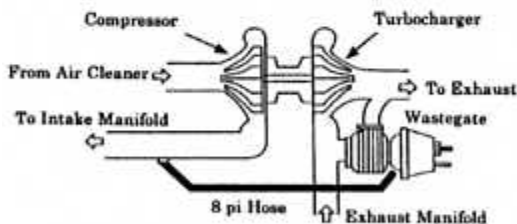

Factory Hosing Diagram

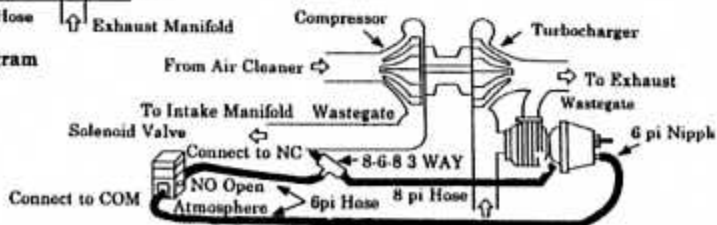

AVC-D Hosing Diagram

Actuator Type (Internal) Wastegate Hosing Diagram
IMPROPER HOISING CONNECTIONS WILL RESULT IN FAULTY OPERATION OF THIS UNIT. Please be sure to double check all hosing before operation.

Vehicles with Factory Boost Control Solenoid Valves (1)

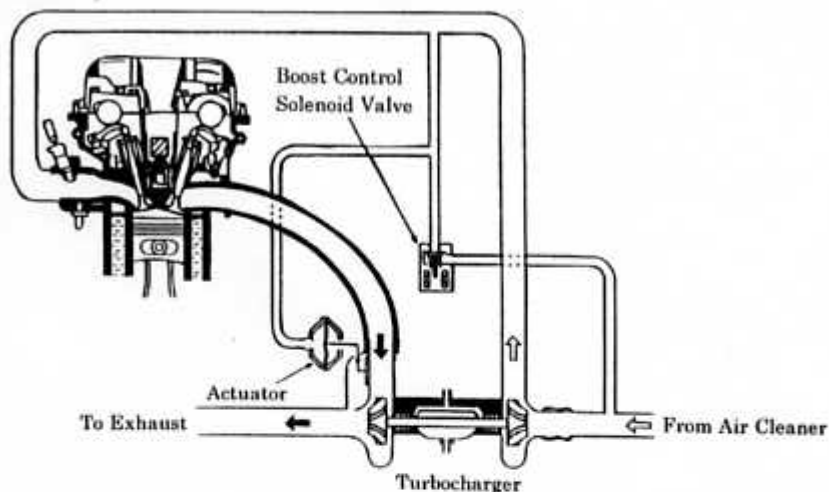

Factory Hosing Diagram

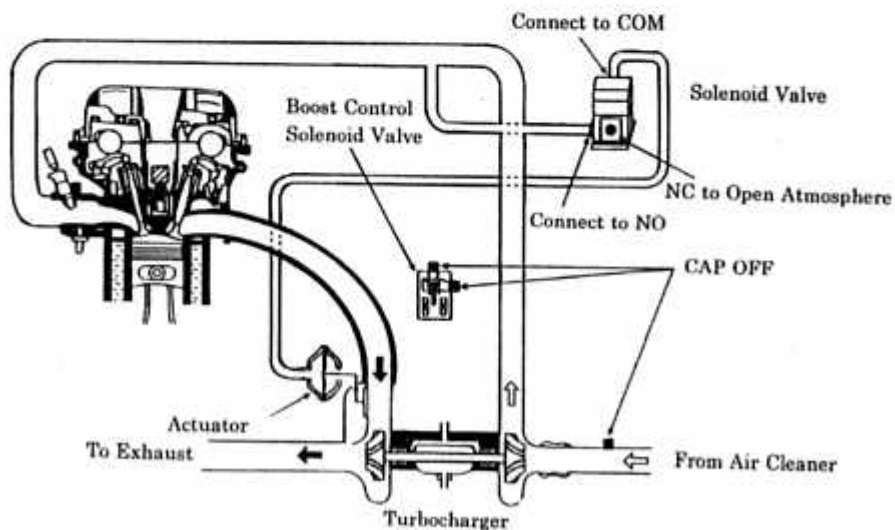

AVC-D Hosing Diagram

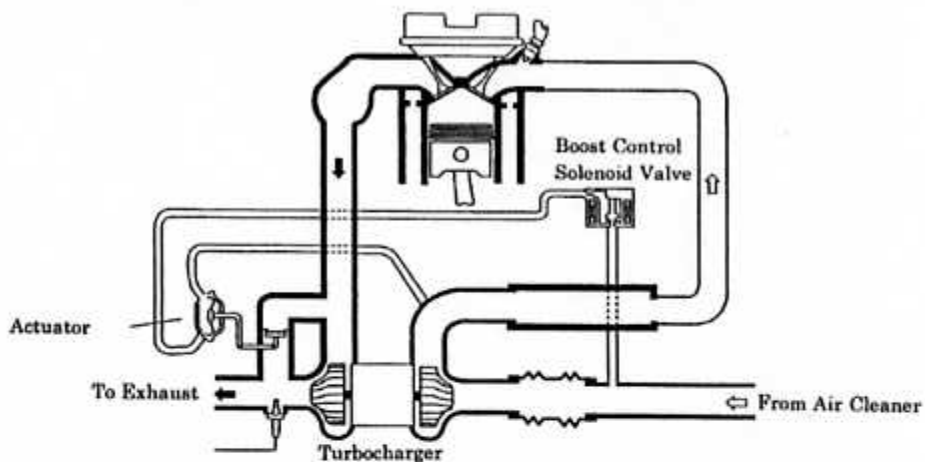

Factory Hosing Diagram

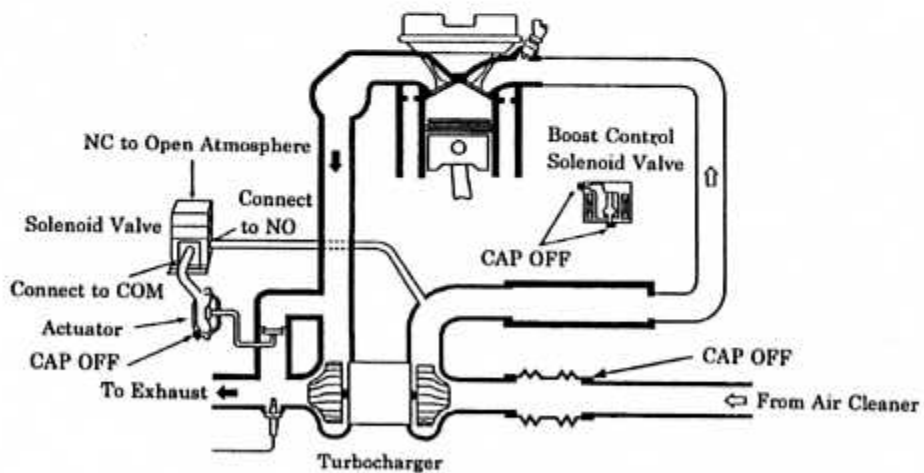

AVC-D Hosing Diagram

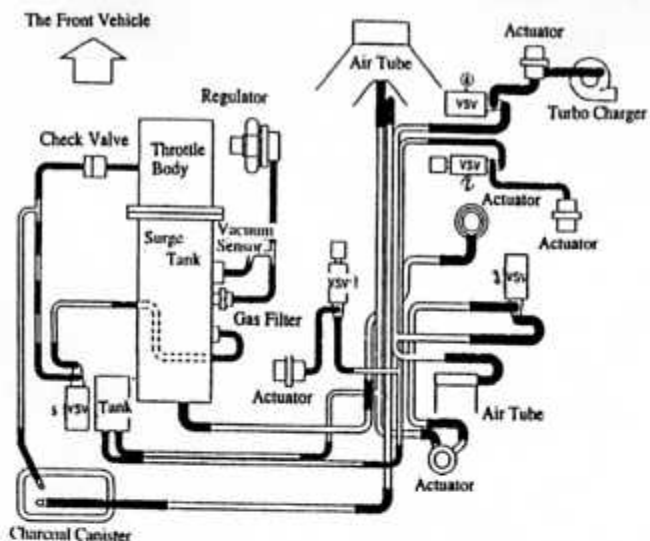

Factory Hosing Diagram

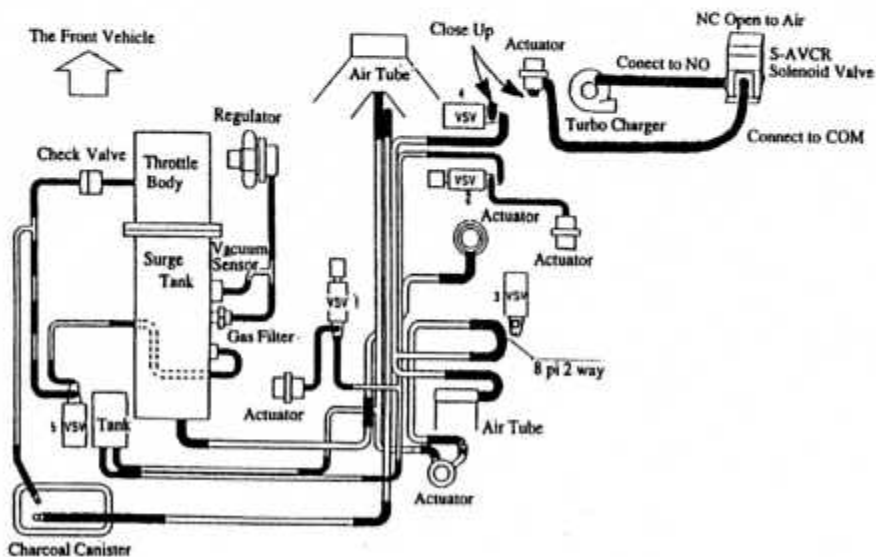

AVC-D Hosing Diagram

FD3S Hosing Diagram

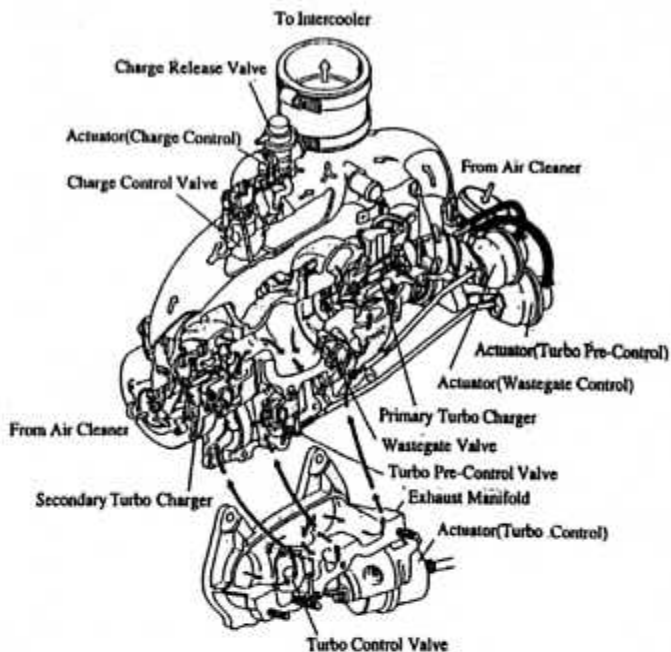

Factory Hosing Diagram

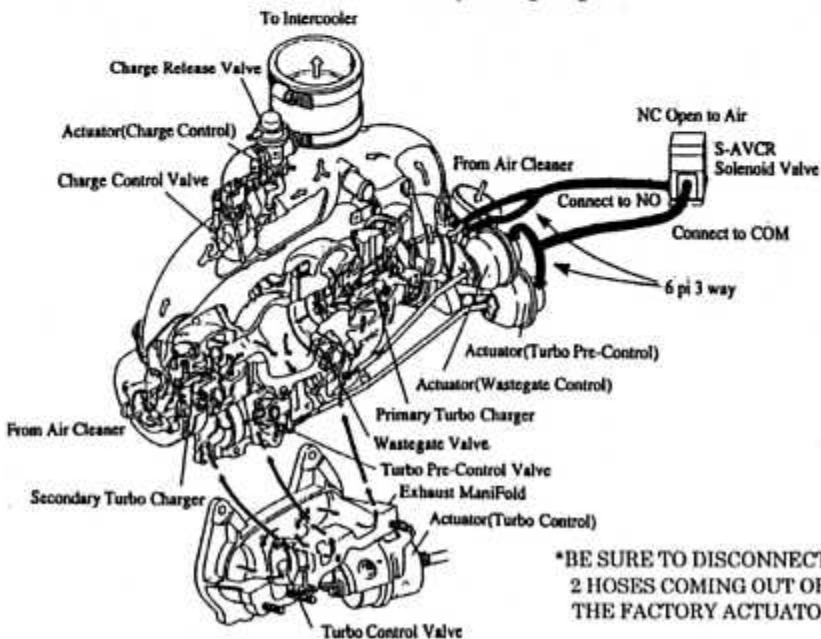

***BE SURE TO DISCONNECT AND CAP OFF THE 2 HOSES COMING OUT OF THE BACK SIDE OF THE FACTORY ACTUATORS.**

AVC-D Hosing Diagram

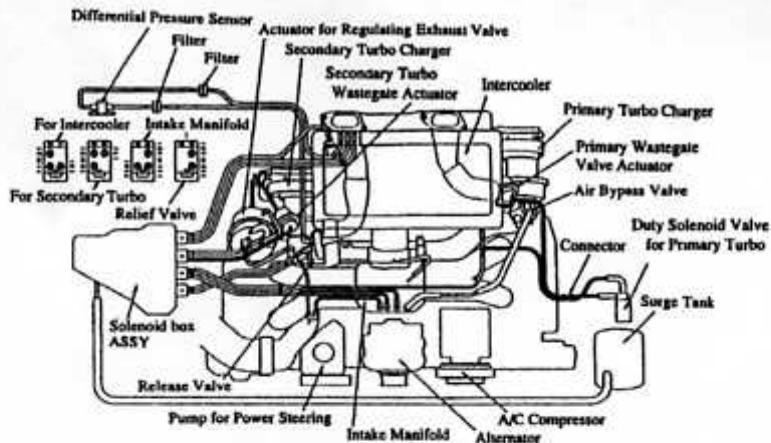

Factory Hosing Diagram

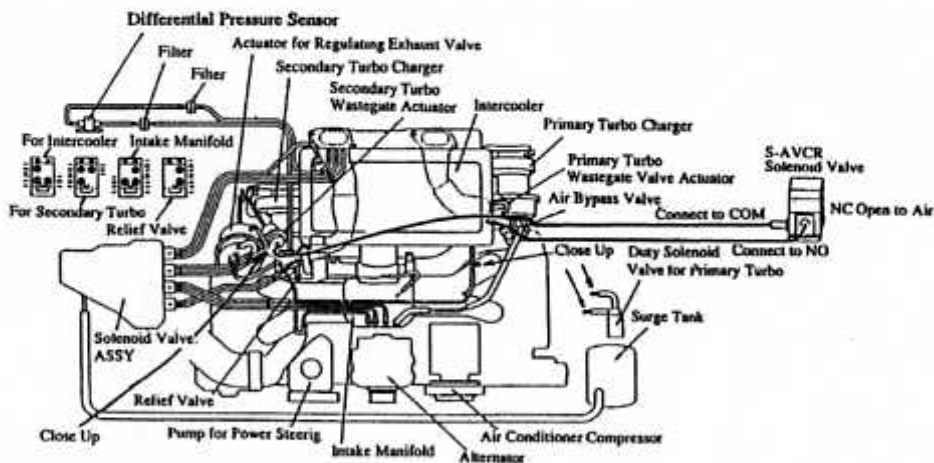

1. Connect the PR And Secondary wastegate actuators together with a hose and then insert a 3 WAY in between the hose. Connect the open side of the 3 WAY to the COM nipple on the solenoid valve.
 2. Connect a hose between the PR compressor housing and the NO nipple.
- * The factory hose diameter is 4 pi. Please use a transition from 4 to 6 pi.

AVC-D Hosing Diagram

* For cars produced after June of 1996 (including the EJ20R,) please connect the primary turbo only like a single turbo application.

CN9A Hosing Diagram

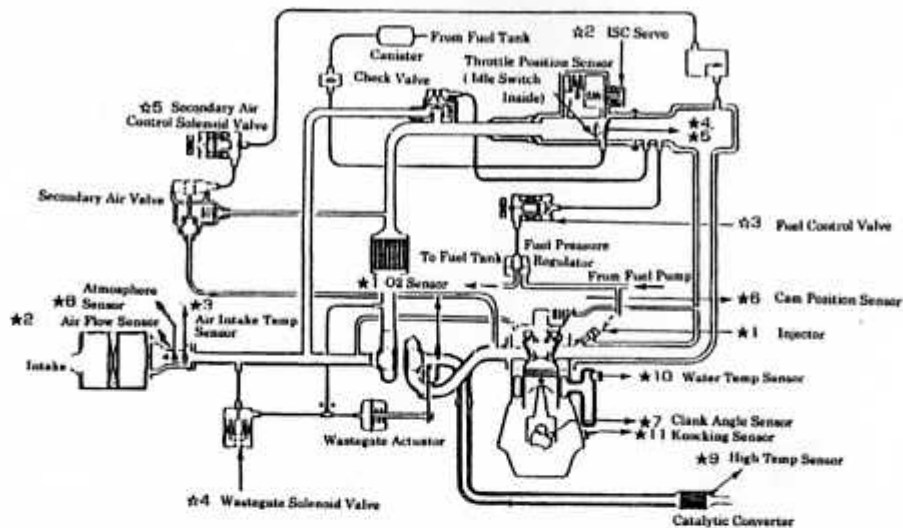

Factory Hosing Diagram

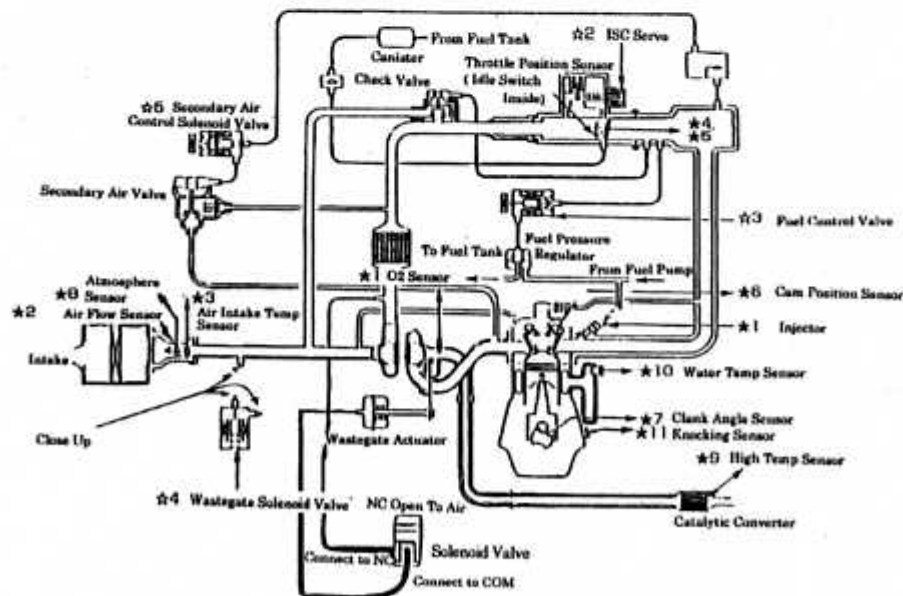

AVC-D Hosing Diagram

EC5A / EC5W Hosing Diagram

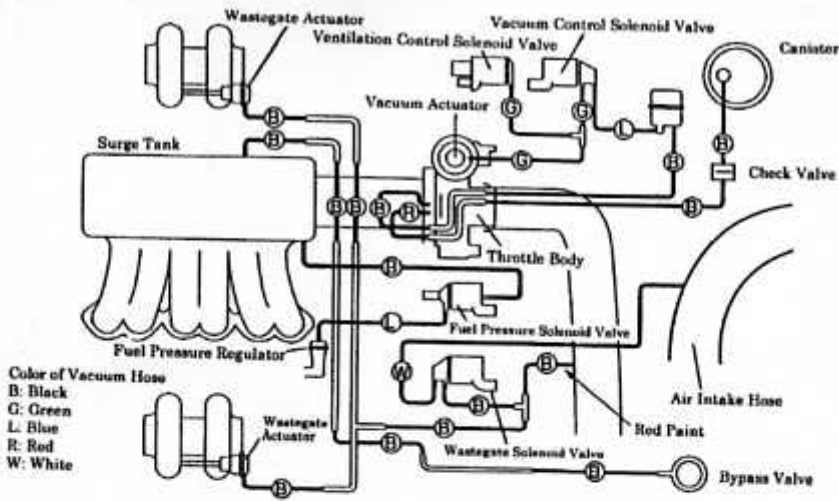

Factory Hosing Diagram

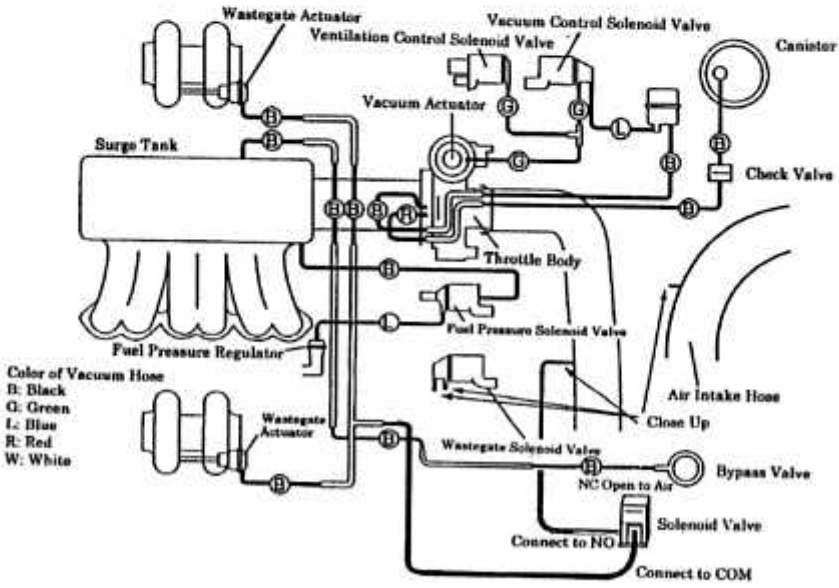

AVC-D Hosing Diagram

Mounting Instructions

- 1) Connect the 6P coupler to the back of the Main Control Unit
- 2) Use the included double sided tape to mount the control unit. Be sure to wipe any excess oil off of the surface prior to mounting.

⚠ CAUTION

- * Be sure to mount the unit in a position which does not interfere with driving operation. Failure to do so may increase the risk of accidents.

⚠ CAUTION

- * Avoid mounting the unit under direct sunlight, and near heating ducts. Excessive heat may cause the unit to malfunction and damage the engine and turbocharger.

- 3) Use zip ties to secure the control unit, and harnesses away from high temperatures and moving parts. (Zip ties are not included in this unit. Please purchase these items separately.)

⚠ CAUTION

- * When routing the harness near moving parts, be sure to prevent any contact between the harness and moving parts. Failure to do so may cause an electrical short in the harness which could prevent proper operation of this unit and cause damage to the engine and turbocharger.

- 4) Double check the control unit and harness installation.
- 5) Reconnect the negative terminal of the battery.
This concludes the installation of this unit.

Check Points After Installation

Please double check these points after installation.

- 1) Are the hoses connected properly?
- 2) Has the factory boost control solenoid valve been properly capped off?
- 3) Have any of the hoses been unnecessarily stretched or kinked?
- 4) Are all hose clamps securely fastened?
- 5) Is the solenoid valve mounted securely?
- 6) Are the harnesses and hoses mounted securely?
- 7) Is the wiring correct?
- 8) Is the negative terminal of the battery securely connected?

Please start the engine and double check the following points.

- 1) Is there any air leak from hoses or other areas affected by installation?
- 2) Check solenoid valve operation by keeping the engine RPM at 2000 RPM.
- 3) Stop the engine and check to see if any hoses have come loose.

Operation and Setting Instructions

The duty setting of this unit is determined by the solenoid valve duty cycle. This **BASE DUTY CYCLE** is adjustable according to engine RPM (3 position setting.)

If the ratio of the duty cycle "ON" time is longer, the boost level will be **HIGHER**. Using this **BASE DUTY CYCLE** as a reference point, boost level correction under load as well as boost level correction according to vehicle speed under drag racing situations can be achieved.

The vehicle speed correction function takes the **BASE DUTY SETTING** at 0 km/h and modifies it 0.5-1.5 times the **BASE DUTY SETTING** up until the preset **SET SPEED** level. The unit will modify this **BASE DUTY SETTING** up to the **SET SPEED** level by taking the **CORRECTION FACTOR X 1**.

Also, by adding a separately sold switch, the **BASE DUTY SETTING** can be raised (scramble boost) or lowered (Traction Boost) for a preset amount of time -50%+50% for a period of between 0-30 seconds.

Individual Volume Characteristics

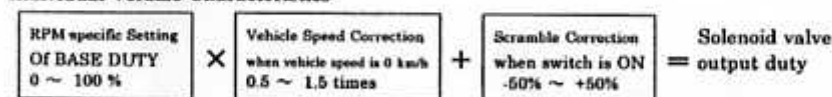

RPM Specific Setting Example

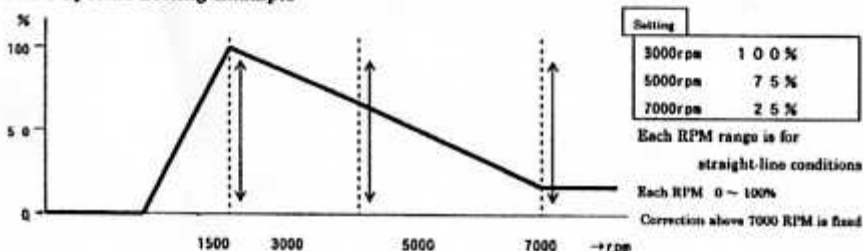

Vehicle Speed Correction Example

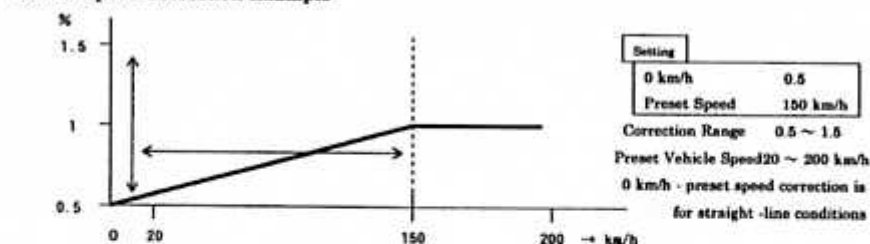

* Because the vehicle speed correction function uses the **BASE DUTY SETTING** as a reference point, the vehicle correction will multiply " 0 x " when the **BASE DUTY SETTING** is set at 0%.

Scramble Setting Example



* If the trigger is depressed again **DURING** a scramble boost session, the preset time range will reset to the last time the switch is depressed.

Knob Illumination

	Power ON	0~ 4000rpm	4001~ 6000rpm	6001rpm~	Under preset speed	Over preset speed	SCB ON within preset time limit
3000rpm	Green	Red	Green	Green	—	—	—
5000rpm	Green	Green	Red	Green	—	—	—
7000rpm	Green	Green	Green	Red	—	—	—
Vehicle speed correction	Green	—	—	—	Green	Red	—
SCB Setting	Green	—	—	—	—	—	Red (Blinking)

* The knob illumination will change according to conditions

Duty Setting Tips for Various Settings

The Definition of DUTY

The AVC-D controls boost pressure by regulating the ON/OFF movement of the solenoid valve. This instruction manual takes the rate of the solenoid valve ON time and calls this DUTY. For example, IF the solenoid valve is monitored for a 40 mSec amount of time and the solenoid is ON for 30 mSec/ OFF for 10 mSec, THEN the DUTY is 75%. (Please refer to the formula below)

$$30 / 40 \times 100\% = 75\%$$

Although the boost levels will increase as the DUTY rate increases, the DUTY will never exceed 100%. In some cases, the boost may not rise even at 100% DUTY due to various engine and turbocharger conditions. On the same note, the boost may rise even at 0 % DUTY due to various engine and turbocharger conditions.

How to categorize various DUTY types

BASE DUTY

0% (Minimal Boost Level Setting) - 100% (Maximum Boost Level Setting)

VEHICLE SPEED CORRECTION

0.5 times (Minimum Vehicle Speed Correction Value) ~ 1.0 times (No Vehicle Speed Correction) ~ 1.5 times (Maximum Vehicle Speed Correction Value)

* The Vehicle Speed Correction Value is MULTIPLIED by the BASE DUTY value.

* Remember that when the preset vehicle speed is reached, the speed correction value will be 1.0 times the BASE DUTY.

For Example IF: Preset Vehicle Speed is 100 km/h
The Vehicle Speed Correction Knob is at 0.6
The Vehicle Speed is at 50 km/h
THEN: The Vehicle Speed Correction Value is 0.8

Scramble Correction Duty

-50% ~ 0% (No Scramble Correction) ~ +50%

* The Scramble Correction Value is ADDED to the BASE DUTY value.

Setting Example

* IF: BASE DUTY is 30%, Vehicle Speed Correction is 0.5, Scramble Correction is +50%
THEN: $30 \times 0.5 + 50 = 65\%$

The final DUTY value of the solenoid is 65%.

* IF: BASE DUTY is 80%, Vehicle Speed Correction is 1.5, Scramble Correction is -10%
THEN: $80 \times 1.5 + (-10) = 110\%$

IN THIS CASE, THE DUTY WOULD BE 100%. (Duty cannot exceed 100%) The scramble correction would not be effectively working in this case.)

About the Optional Parts

* The following optional parts have been prepared for this unit. Please order these parts according to necessity.

430-A001	Twin Turbo Accessories		
430-A002	Wastegate Accessories		
9933 0020	Zip Ties	L=200	10
9933 0030	Zip Ties	L=100	10
9933 0040	Zip Ties	L=150	10

In Case of Product Malfunction

⚠ WARNING

* If the unit produces unusual sounds or smells during operation, discontinue use immediately and return the unit to the dealer of purchase with a valid receipt. Continued use may result in electrical short or electrical fire and may damage the unit and vehicle.

⚠ CAUTION

* Never disassemble this unit or attempt to repair the unit on your own. Improper repairs may result in electrical fire and electrical short.

Product Specifications

Operating Voltage	DC10 ~ 16 V
Operating Temperature	-20 ~ +60 degrees Celsius

