

# TRIP COMPUTER

## WIRING DIAGRAM

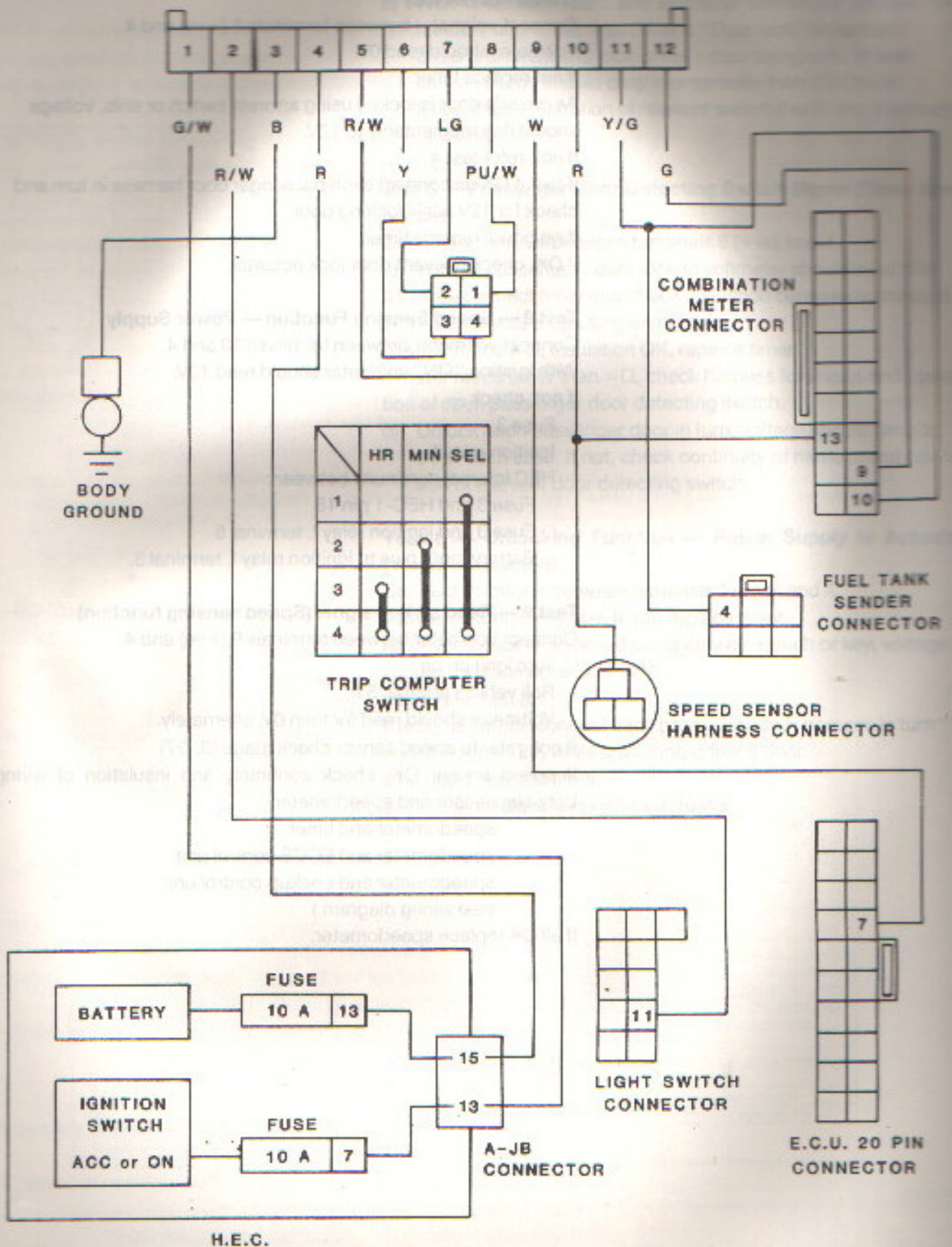

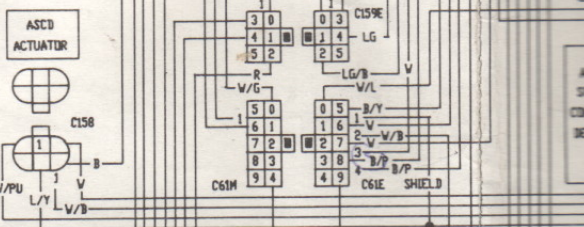

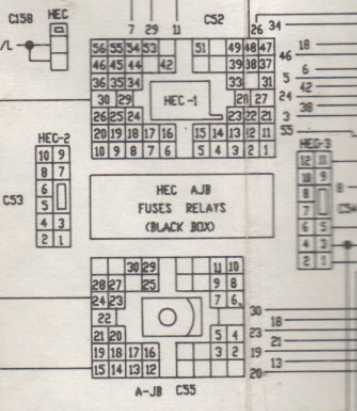
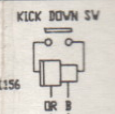
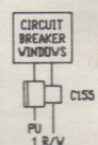
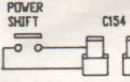
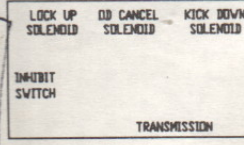
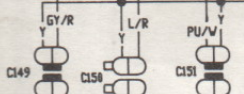
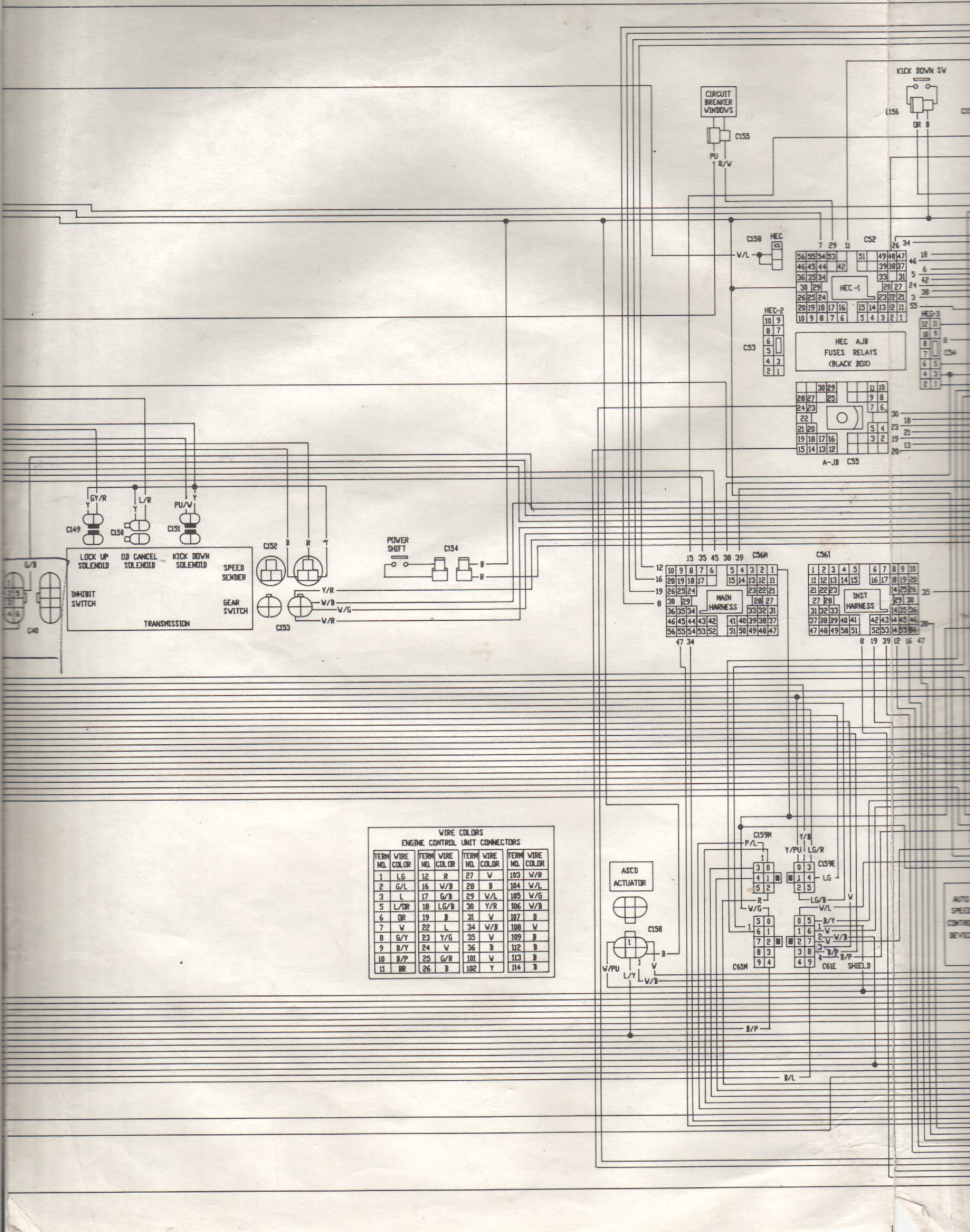

**WIRE COLORS**  
ENGINE CONTROL UNIT CONNECTORS

TERM. NO.	WIRE COLOR	TERM. NO.	WIRE COLOR	TERM. NO.	WIRE COLOR	TERM. NO.	WIRE COLOR
1	LG	12	R	27	V	103	V/R
2	G/L	16	W/B	28	B	104	V/L
3	L	17	G/B	29	V/L	105	V/G
5	L/DR	18	LG/B	30	Y/R	106	W/B
6	DR	19	B	31	V	107	B
7	V	22	L	34	V/B	108	V
8	G/Y	23	Y/G	35	V	109	B
9	B/Y	24	V	36	B	112	B
10	B/P	25	G/R	101	V	113	B
11	BR	26	B	102	Y	114	B



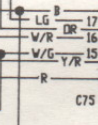
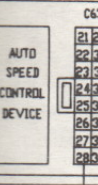
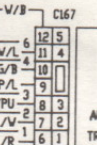
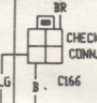
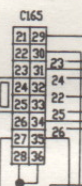
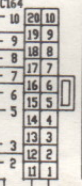
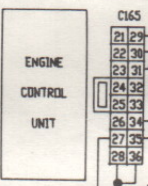
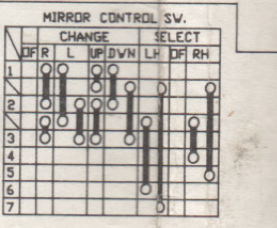
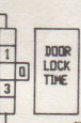
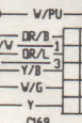
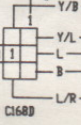
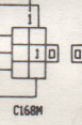
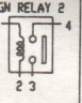
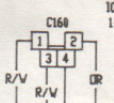
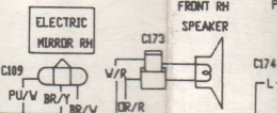
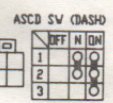
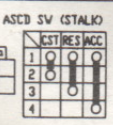
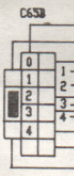
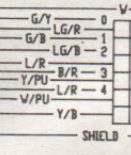
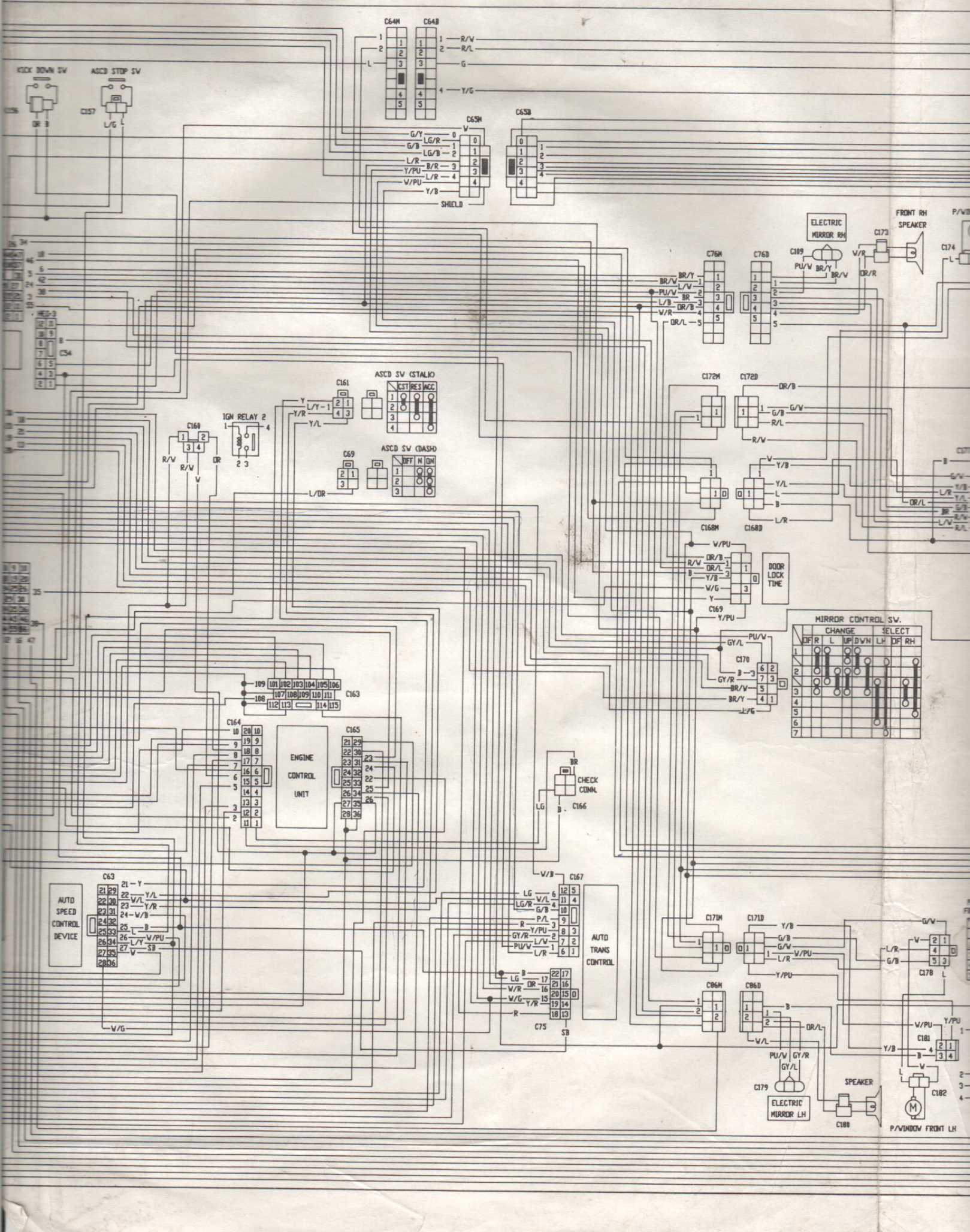



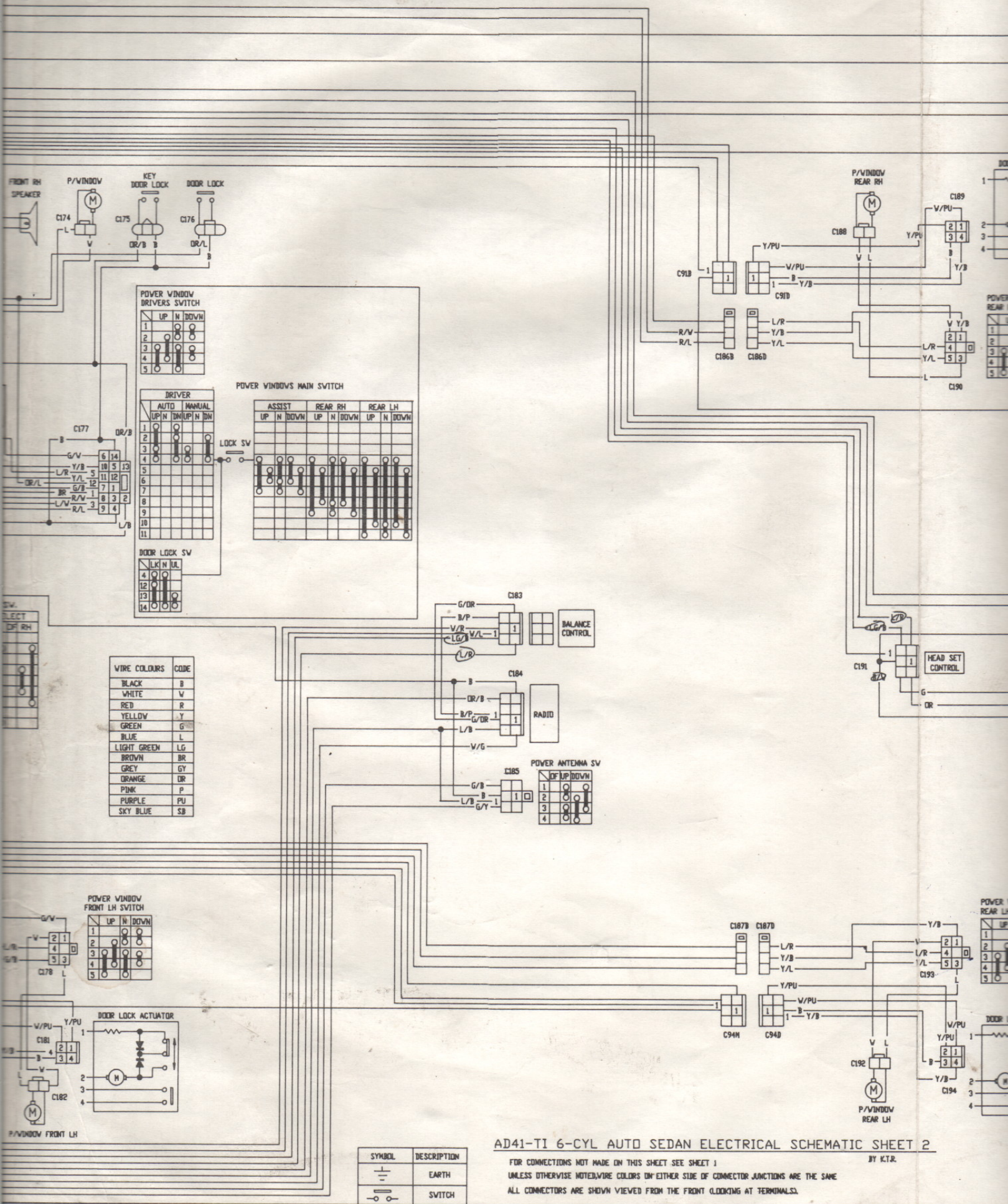

WIRE COLOURS	CODE
BLACK	B
WHITE	W
RED	R
YELLOW	Y
GREEN	G
BLUE	L
LIGHT GREEN	LG
BROWN	BR
GREY	GY
ORANGE	OR
PINK	P
PURPLE	PU
SKY BLUE	SB

SYMBOL	DESCRIPTION
	EARTH
	SWITCH

AD41-TI 6-CYL AUTO SEDAN ELECTRICAL SCHEMATIC SHEET 2

FOR CONNECTIONS NOT MADE ON THIS SHEET SEE SHEET 1  
 UNLESS OTHERWISE NOTED, WIRE COLORS ON EITHER SIDE OF CONNECTOR JUNCTIONS ARE THE SAME  
 ALL CONNECTORS ARE SHOWN VIEWED FROM THE FRONT (LOOKING AT TERMINALS).

BY K.T.R.



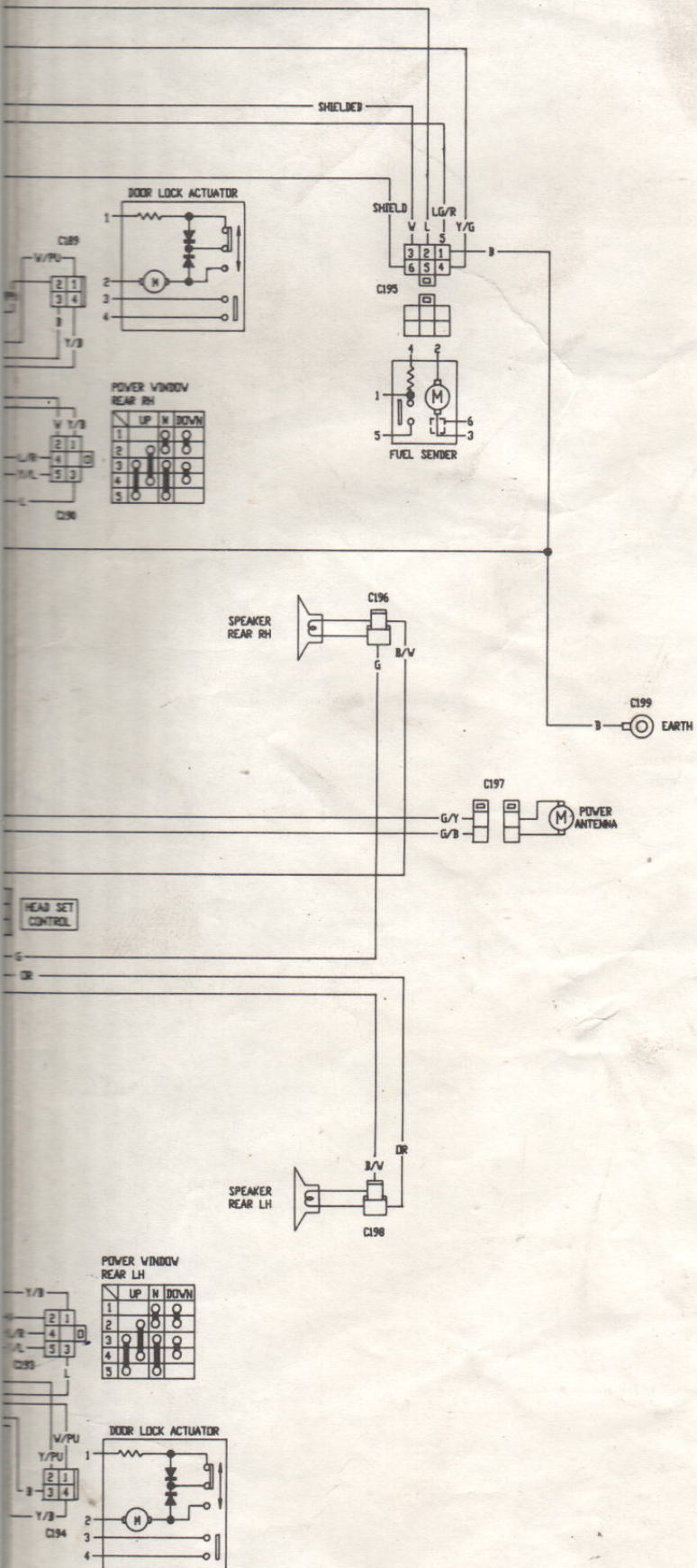



CAR FRONT

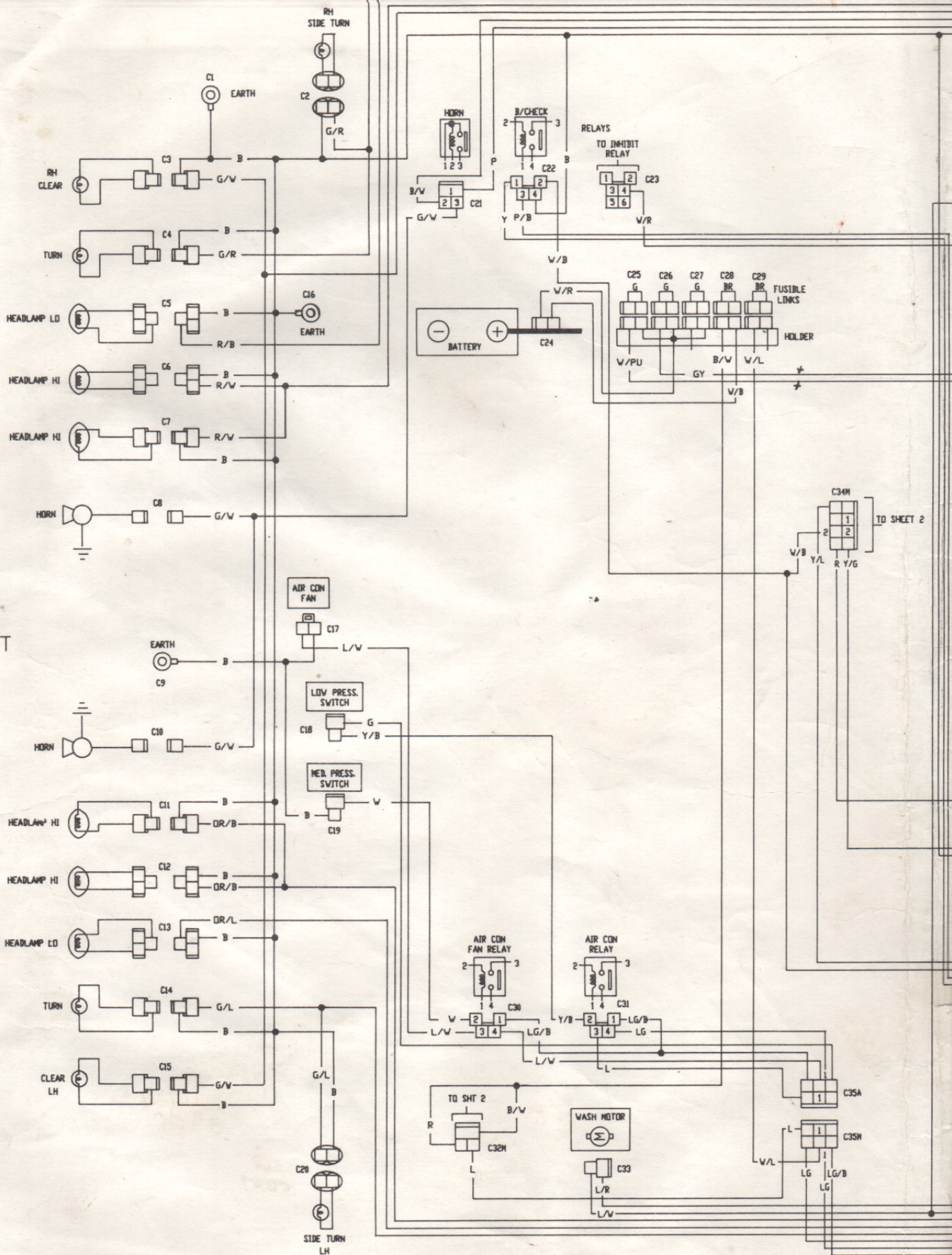

TO SHEET 2



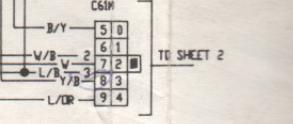
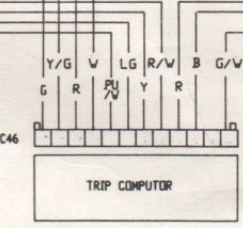
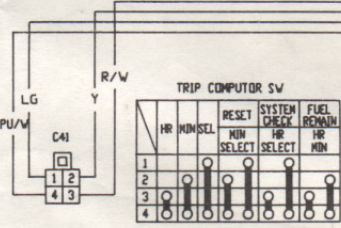
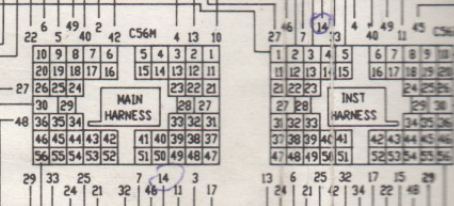
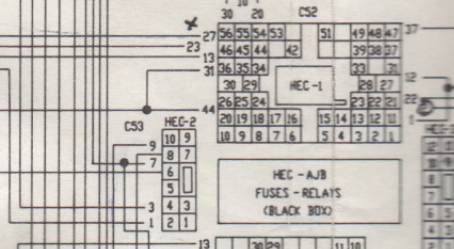
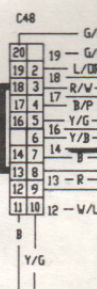
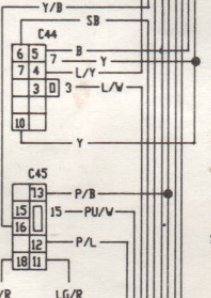
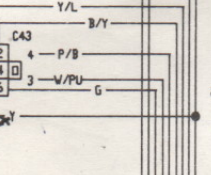
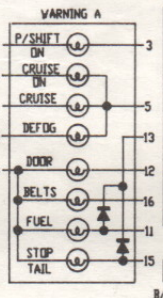
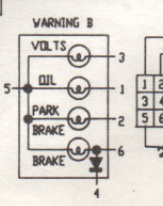
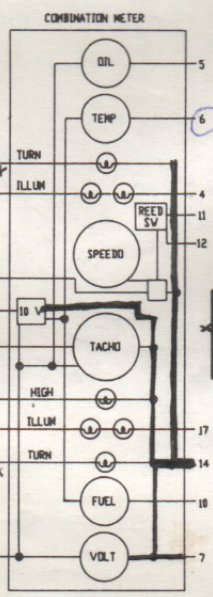
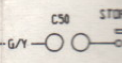
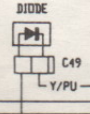
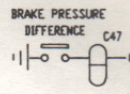
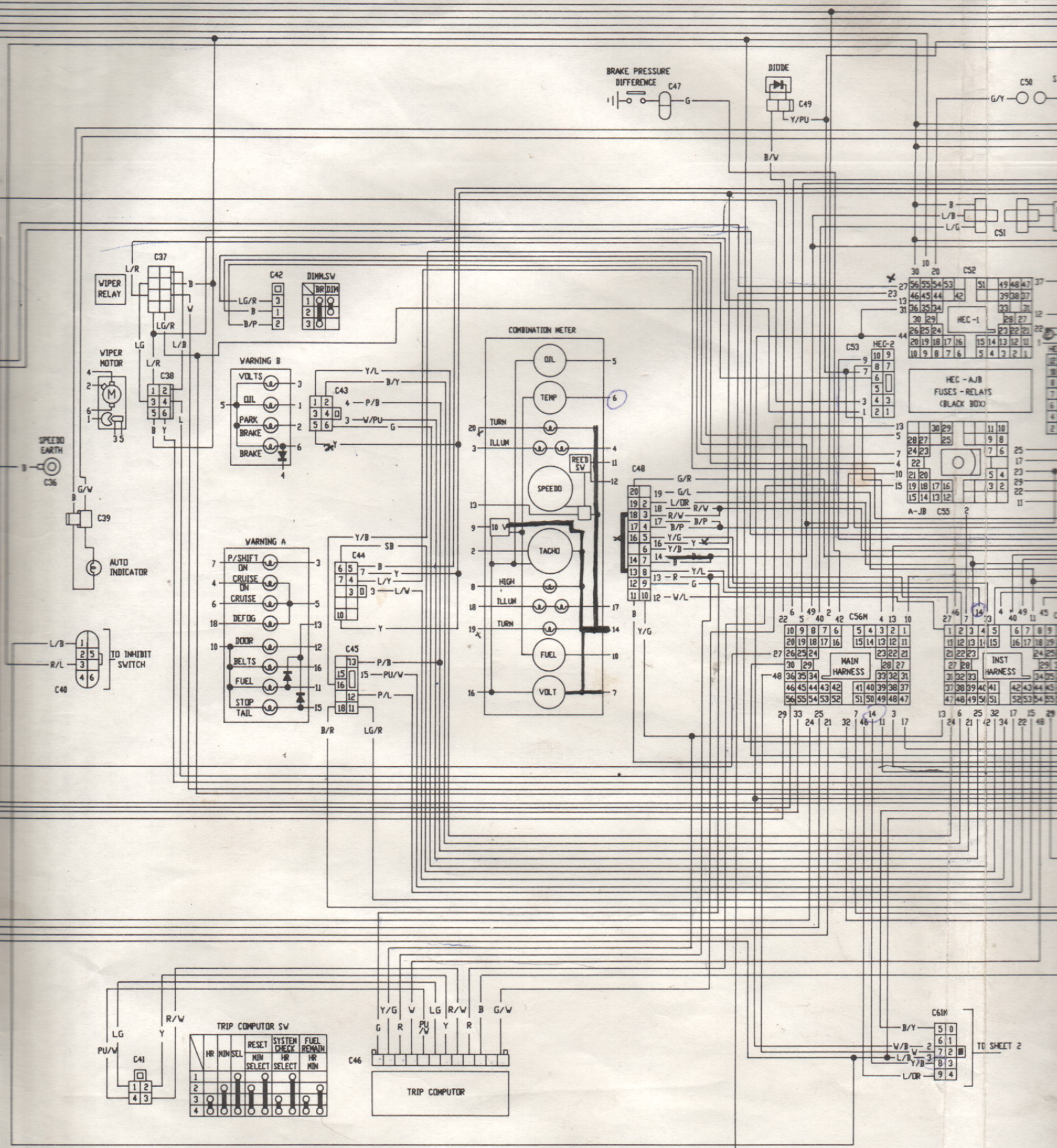



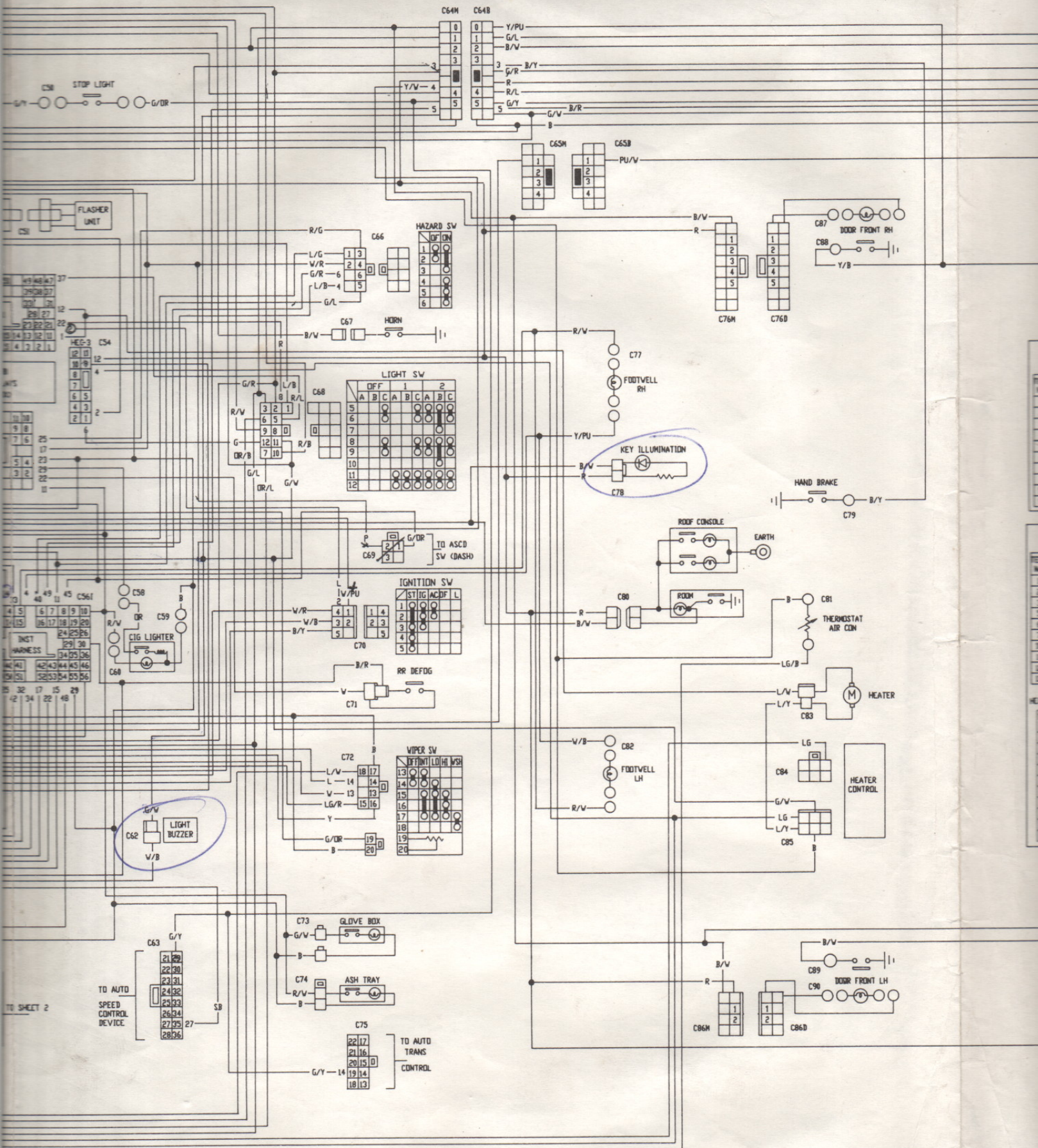

TO SHEET 2

SYMBOL	DESCRIPTION
	EARTH
	SWITCH
	BULB

AD41  
FOR C  
UNLESS  
ALL C



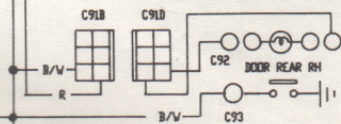

**WIRE COLORS  
MAIN & INSTRUMENT HARNESS  
CONNECTORS**

TERM. NO.	WIRE COLOR	TERM. NO.	WIRE COLOR	TERM. NO.	WIRE COLOR	TERM. NO.	WIRE COLOR
1	V/L	12	L/R	25	V/PU	40	L/G
2	Y/L	13	Y/G	27	R	41	B/P
3	G/R	14	Y/B	29	B	42	G
4	Y/PU	15	LG/R	30	B/R	45	P
5	R/V	16	LG/B	32	SB	46	L/DR
6	B/Y	17	PU/V	33	Y/G	47	W/L
7	W/B	19	G/B	34	L/V	48	W
8	G/Y	21	P/B	35	L/DR	49	L/B
10	G/V	22	P/L	38	V/R	56	B
11	G/L	24	Y/L	39	DR/B		

**WIRE COLORS  
A-JB CONNECTOR**

TERM. NO.	WIRE COLOR	TERM. NO.	WIRE COLOR
2	V/B	19	BR/V
4	Y/B	20	BR/Y
5	LG/R	21	GY/R
7	B/P	22	W
10	B/P	23	B
11	R/V	24	L/B
13	L/G	25	R/G
15	R	29	DR
17	Y	30	PU/V
18	GY/L		

**WIRE COLORS  
HC-1 CONNECTOR**

TERM. No.	WIRE COLOR	TERM. No.	WIRE COLOR	TERM. No.	WIRE COLOR
1	L/V	18	Y	34	W
2	L	20	G/Y	37	R/L
3	GY/R	22	R	38	L/R
5	BR/V	23	L/R	42	L/V
6	BR/Y	24	PU/V	44	V/B
7	G/DR	26	L/R	46	R/V
10	P	27	GY	48	L/R
11	G	29	R/V	55	L/R
12	L/V	30	B		
13	L/R	31	W/B		

**FUSE No. LAYOUT**

1	2	3	4	5	6	7	8	9	10	11
12	13	14	15	16	17	18	19	20	21	22

**WIRE COLORS CODE**

BLACK	B
WHITE	W
RED	R
YELLOW	Y
GREEN	G
BLUE	L
LIGHT GREEN	LG
BROWN	BR
GREY	GY
ORANGE	DR
PINK	P
PURPLE	PU
SKY BLUE	SB

**HEC-2 CONNECTOR**

TERM. No.	WIRE COLOR
1	DR
3	L/V
6	L/R
7	Y/PU
8	G/DR
9	B/V

**HEC-3 CONNECTOR**

TERM. No.	WIRE COLOR
1	BR
2	B
3	Y
4	LG
5	L/B
6	G
8	GY/B
9	L/B
11	L
12	R

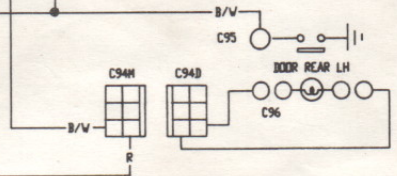

FOR CONNECTIONS NOT MADE ON THIS SHEET SEE SHEET 2.  
UNLESS OTHERWISE NOTED, WIRE COLOURS ON EITHER SIDE OF CONNECTOR JUNCTION ARE THE SAME  
ALL CONNECTORS ARE SHOWN VIEWED FROM THE FRONT (LOOKING AT TERMINALS)



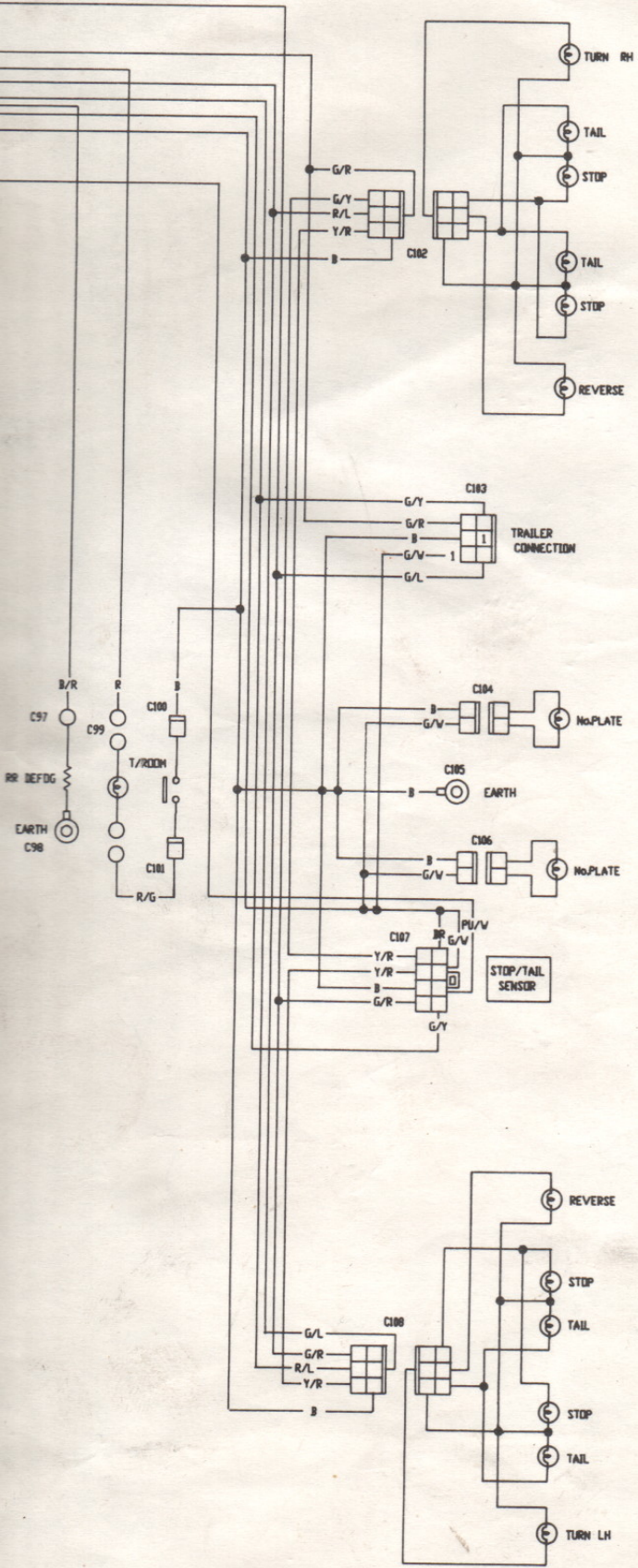



AD41 6-CYL MANUAL GEARBOX ELECTRICAL SCHEMATIC

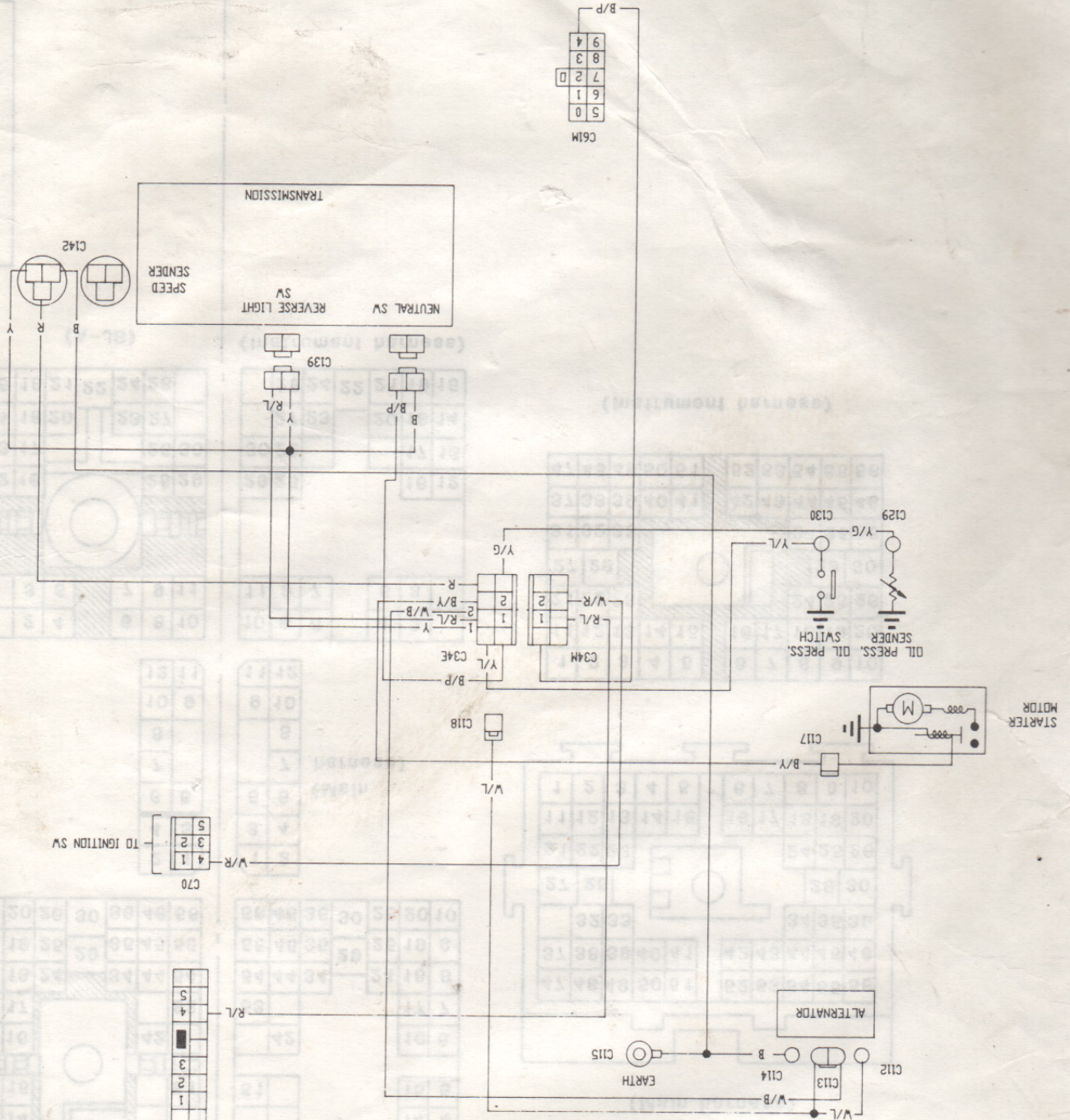

WIRE CODE	WIRE COLORS
B	BLACK
W	WHITE
R	RED
Y	YELLOW
G	GREEN
L	BLUE
LG	LIGHT GREEN
BR	BROWN
GY	GREY
DR	ORANGE
P	PINK
PU	PURPLE
SB	SKY BLUE

5	4	3	2	1
---	---	---	---	---

5	4	3	2	1
---	---	---	---	---

9	8	7	6	5
4	3	2	1	0



- 1 - G
  - 2 - 1/6
  - 3 - R
  - 4 - W
  - 5 - R/W
  - 6 - 4/6
  - 7 - Y
  - 8 - R/W
  - 9 - R
  - 10 - B
  - 11 - G/W
- |   |         |
|---|---------|
| } | 3 - R/W |
| } | 1 - 4/6 |
| } | 2 - Y   |
| } | 4 - R/W |
| } | 5 - W/G |
| } | 6 - B   |
| } | 8 - G/W |

11 pin ← 8 pin

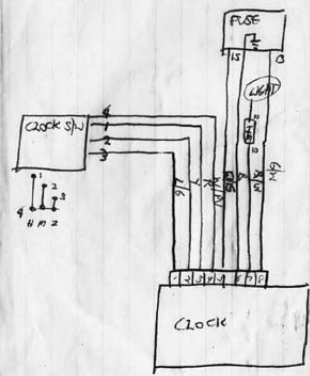
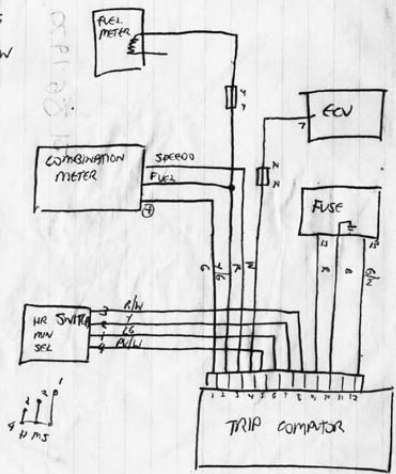



# TRIP COMATOR.

